

# Public Transportation

## JOURNAL OF

- 
- Sergej Težak, Ph.D.  
Drago Sever, Ph. D.  
Marjan Lep, Ph.D. Increasing the Capacities of Cable Cars  
for Use in Public Transport
- 
- Abigail S. Golden  
Roberta E. Weisbrod Trends, Causal Analysis, and Recommendations  
from 14 Years of Ferry Accidents
- 
- Eunice V. Akoto, Ph.D. Exploring Diversified Performance Indicators for Evaluating  
Non-Urbanized Transit Program Outcomes
- 
- Anne E. Brown  
Evelyn Blumenberg  
Kelcie Ralph  
Brian D. Taylor  
Carole Turley Voulgaris A Taste for Transit?  
Analyzing Public Transit Use Trends among Youth
- 
- Geetika  
Piyali Ghosh  
Mohit Kumar Ojha  
Sumit Kumar Journey towards World Class Stations:  
An Assessment of Platform Amenities at Allahabad Junction
- 
- Peiyu Feng  
Wenquan Li Willingness to Use a Public Bicycle System:  
An Example in Nanjing City
- 
- Subeh Chowdhury  
Kasey Zhai  
Asif Khan The Effects of Access and Accessibility  
on Public Transport Users' Attitudes
- 
- Houman Shadab Mehr  
Mohamad Rahim Rahnama  
Mohamad Ajza Shokouhi  
Ezatollah Mafi Optimization of Main Public Transport Paths  
Based on Accessibility—Case Study: Mashhad, Iran

Joel Volinski, *Editor*  
Lisa Ravenscroft, *Assistant to the Editor*

## EDITORIAL BOARD

---

Robert B. Cervero, Ph.D.  
*University of California, Berkeley*

William W. Millar  
*American Public Transportation Association*

Chester E. Colby  
*E & J Consulting*

Steven E. Polzin, Ph.D., P.E.  
*University of South Florida*

Gordon Fielding, Ph.D.  
*University of California, Irvine*

Lawrence Schulman  
*LS Associates*

Jose A. Gómez-Ibáñez, Ph.D.  
*Harvard University*

George Smerk, D.B.A.  
*Indiana University*

Naomi W. Ledé, Ph.D.  
*Texas Transportation Institute*

Vukan R. Vuchic, Ph.D., P.E.  
*University of Pennsylvania*

The contents of this document reflect the views of the authors, who are responsible for the facts and the accuracy of the information presented herein. This document is disseminated under the sponsorship of the U.S. Department of Transportation, University Research Institute Program, in the interest of information exchange. The U.S. Government assumes no liability for the contents or use thereof.

## CONTENTS

---

<b>Increasing the Capacities of Cable Cars for Use in Public Transport</b> <i>Sergej Težak, Ph.D., Drago Sever, Ph. D., Marjan Lep, Ph.D.</i> .....	1
<b>Trends, Causal Analysis, and Recommendations from 14 Years of Ferry Accidents</b> <i>Abigail S. Golden, Roberta E. Weisbrod</i> .....	17
<b>Exploring Diversified Performance Indicators for Evaluating Non-Urbanized Transit Program Outcomes</b> <i>Eunice V. Akoto, Ph.D.</i> .....	28
<b>A Taste for Transit? Analyzing Public Transit Use Trends among Youth</b> <i>Anne E. Brown, Evelyn Blumenberg, Brian D. Taylor, Kelcie Ralph, Carole Turley Voulgaris</i> .....	49
<b>Journey towards World Class Stations: An Assessment of Platform Amenities at Allahabad Junction</b> <i>Geetika, Piyali Ghosh, Mohit Kumar Ojha, Sumit Kumar</i> .....	68
<b>Willingness to Use a Public Bicycle System: An Example in Nanjing City</b> <i>Peiyu Feng, Wenquan Li</i> .....	84
<b>The Effects of Access and Accessibility on Public Transport Users' Attitudes</b> <i>Subeh Chowdhury, Kasey Zhai, Asif Khan</i> .....	97
<b>Optimization of Main Public Transport Paths Based on Accessibility— Case Study: Mashhad, Iran</b> <i>Houman Shadab Mehr, Mohamad Rahim Rahnama, Mohamad Ajza Shokouhi, Ezatollah Mafi</i> .....	114

---

# Increasing the Capacities of Cable Cars for Use in Public Transport

Sergej Težak, Ph.D., Drago Sever, Ph. D., Marjan Lep, Ph.D.  
University of Maribor, Slovenia

---

## Abstract

*This paper examines the advantages and disadvantages of cable cars in public transport within urban areas. The advantages of cable car transport compared to other modes of transport are its quiet operation with an environmentally-acceptable electric drive and the possibility of transporting passengers above the ground, which can provide additional transport dimensions within urban centers. However, cable cars have some disadvantages, especially their smaller capacities in relation to other modes of transport within the urban environment. Today's built cable cars have capacities up to 2,000 persons/h for aerial tramways (or jig-back ropeways) and up to 4,000 persons/h for gondolas.*

*Solutions are introduced in this paper as to how the current cable car technologies can increase the capacities of these devices. This can be achieved by concentrating on the vehicles (cabins) on gondola lines and by using multiple platforms at starting stations and final stations. It also provides a solution for intermediate stations, at which vehicles can be stopped independent of other vehicles on the line.*

**Keywords:** Cable cars, cableways, gondolas, public transport, geometric modeling, capacity, boarding

## Introduction

The mobility of the population has always been important within the context of socioeconomic and technical-technological points of view. However, there is an increasingly important ecological aspect regarding sustainable development. The main cases of technical-technological aspects can be seen in motorized vehicles, where, through emission standards, the harm from exhaust gases in the environment and in regard to the population is reduced.

Vehicles that use electricity for driving have minimum direct impacts on the environment, especially if the electricity is produced in such a way that it does not pollute the environment. In any event, for densely-populated urban environments, such as large cities, it would be extremely favorable if people were to use electrically-driven

vehicles for mobility. This would represent the minimum impact on the environment—no harmful exhaust emissions, which is still a major problem in most cities. Electric-powered trams, trolleybuses, metros, and, more recently, electric cars and buses already are used in cities. However, a problem with today's urban mobility is that it takes place mainly at ground level, and, as a result, streets and city roads are very busy, thus causing congestion. In larger cities, where the demands for transportation services are greater, transport also takes place underground using subways. Regrettably, spaces at ground levels in cities remain unexploited.

As a subsystem of a transport system, cable car transport holds a specific place because it makes accessible those places that are interesting from the aspect of tourism as well as those that are difficult to access via other transport subsystems (Sever 2002). Cable car transport is carried out using cable cars that encompass all-aerial cable car facilities. Cable cars use ropes and are usually electrically-powered, but they rarely are used in urban areas; rather, they are used primarily for tourism, especially winter ski resorts. In these areas, in addition to technological efficiency, the economic efficiency of cable car transport has improved, as presented by Brida et al. (2014). In urban environments, funiculars, which came into service as early as the 19<sup>th</sup> century, mostly are used to transport people to locations that are at higher altitudes, especially in regard to tourism; however, they work only over short distances depending on the terrain relief.

Cable cars, especially those operating above ground level (aerial cable cars), have great potential for use in urban environments. Their operation can relieve traffic on the surface in the cities. The problem is that they do not have large capacities for transporting passengers; the maximum capacity for aerial cable cars is 4,000 persons /h. Therefore, they are not competitive relative to other options of passenger transport in urban centers. However, in larger cities such as Medellin, New York, Portland, Caracas, Rio de Janeiro, and La Paz, they already are used as parts of the public transport network. Research towards the direction that aerial cable cars should have greater capacities has not been conducted to date. Funiculars are used for greater capacities in mountainous areas, which go on or under the surface and are faster.

The purpose of this paper is to present new solutions that use existing technology for passenger transport by rope, so that this mode of transport could become more competitive compared to other types of passenger transport in urban areas. Comparisons with existing modes of transport in urban environments also are made and presented, as are the potential advantages and disadvantages of the proposed solutions.

## **Overview of Previous Research**

The uses of cable cars in non-urban environments, especially in mountainous areas and for tourism, have been well studied, but the use of these systems in urban areas and city centers as part of public transport networks have not. Technical solutions on cable cars are fairly well described in various books (such as Doppelmayr 1997; Günthner 1999; Nejez 2006).

The issue regarding the uses of different types of cable cars and comparisons with other transport systems in an urban environment are presented in a study by Clement-Werny

et al. (2011), in which an economic analysis of the construction of existing cable car systems also was given. Experience using gondolas as public transport has occurred more often in various cities of South America. In Medellin, aerial gondola lines were built for use in public transport because bus transport was very badly organized and the transport area is mountainous and difficult to access. Gondolas were built to improve accessibility for poor people who live in these areas of the city. Interestingly, it was observed that better transport accessibility using cable cars also raised real estate prices near the cable car stations, which also was mentioned in research by Bocareo et al. (2014). As Medellin is a representative example of the use of cable cars in public transport, this case has been discussed by many authors, including Heinrichs and Bernet (2014), Dávila (2013), Bocareo et al. (2014), and Brand and Dávila (2011).

Recently, La Paz built gondolas as part of its public transport system, with three gondolas operating with a total length of 10 km (ISR 2015). Cableways also have been built as public transport in the U.S. Portland, Oregon, has an aerial tramway that carries commuters between the Oregon Health & Science University campus (with a hospital) and the city's South Waterfront district, where there is a lower station adjacent to a stop on the Portland Streetcar line. In Telluride and the Montain Village in Colorado, a gondola serves as free public transportation. In other parts of the world, cable cars are used as parts of urban transport systems primarily for tourism purposes. Future trends in the use of cable cars also were indicated by Wu et al. (2013), who noted that cable cars in China play an important role in diverse urban transport networks.

### **Characteristics of Cable Car Transport and Comparison with Other Modes of Transport**

Cable car transport is carried out using aerial cable cars, surface lifts, and funiculars (Doppelmayer 1997). With ski lifts and funiculars (or funicular railways), passengers are carried above ground level; with aerial cable cars, passengers are carried in the air. For this reason, aerial cable cars are more suitable for use in urban environments because they do not burden existing urban traffic routes.

Aerial cable cars have the following advantages compared with other transport modes:

- Independent transport relief (suitable for hilly areas)
- Powered by electricity
- No CO<sub>2</sub> emissions, if renewable energy is used for electricity
- No exhaust emissions
- Significantly-reduced noise emissions (Nikšić 2010)
- No need of surfaces for transport
- High level of traffic safety (according to Oplatka [2008], the rate of injuries in Switzerland was 7,8 persons per 100 million passengers)
- Comfortable transport in the air by rope (vibrations occur only when vehicles pass over the roller batteries)

- No need for the additional weight of a drive mechanism and fuel in the vehicle

Despite their good characteristics, aerial cable cars also have certain limitations:

- Speed limited to 12 m/s or 43,2 km/h
- Capacity limited to 4,000 persons/h
- Suitable only for distances up to 7 km (gondolas with intermediate stations)
- Wind resistance, normally up to 18 m/s (65 km/h), bi-cable systems 90 km/h
- Extensive maintenance and controls
- Difficult to rescue people from aerial cable cars
- Expensive infrastructure (for faster detachable cable cars)
- No heating or air conditioning in cabins
- Potential negative visual impacts of cable cars

According to operating principles, aerial cable cars are divided into aerial tramways and gondolas. Aerial tramways (jig-back ropeways, reversible aerial ropeways) transport passengers using one or two cabins that move back and forth on cables. Their maximum speed is 12 m/s or 43.2 km/h (CEN 2004). With only two cabins, they can overcome greater inclines than gondolas, the span between the pylons can be extraordinarily long (more than 1 km) so they can overcome major gaps and precipices, and they are suitable for distances up to 3 km. The cabins stop completely at stations, so passengers have enough time to enter or exit. As only two cabins are available, they have small capacities (200 persons per cabin, max. 2,000 persons/h), and the average waiting time of passengers at the station is longer; the times of entry and exit (dwell times) also are longer than gondolas.

Gondolas are uni-directional aerial cable cars with circulating vehicles (cabins). They consist of several cabins that can carry up to 30 persons each and have greater capacities than aerial cars, up to 4,000 persons/h. The speed is slower than aerial cars, with a maximum of 7 m/s for bi-cable gondolas and a maximum of 6 m/s for monocable gondolas (CEN 2004). Dwell times are shorter than aerial cars, as the cabins are smaller. Passengers do not need to wait for the vehicles at the station, as the vehicles constantly come and go. The spans between the pylons are smaller than aerial tramways because there is more than one vehicle on the rope at a time, and the lengths of gaps and precipices over which cabins can travel are smaller than for the aerial tramways. When at a station, cabins do not stand still but move slowly through the station, which can make it difficult for persons with disabilities and older adults to enter. Time of entry into the cabin is limited depending on the speed and length of the platform.

Gondolas are the more suitable for public passenger transport, which requires maximum capacity. Aerial tramways are faster; the speed of a gondola—21–25 km/h—is less than the average speeds of buses in urban centers. Tirachini (2013) measured the average speed of city buses, at 38.9 km/h, which during peak hours reduces to 34.4 km/h. The speeds of cable cars are low but, in the case of gondolas, the vehicles come constantly into stations and passengers do not need to wait for them. Aerial cable

car lines can travel outside over streets and buildings, and the distance between the stations can be shorter.

It is clear that the capacities of aerial cars are not competitive with the existing, more-used modes of passenger transport in urban centers. According to the Transport Research Board (2003) and Clement-Werny et al. (2011), types of transport in urban centers have the following capacities:

- Single traffic lane for passenger cars – up to 9,000 persons/h (2,250 passenger cars/h, 4 persons per vehicle)
- Metro – up to 36,000 persons/h
- Buses within mixed traffic – up to 1,250 persons/h
- Light rail on streets – to 11,800 persons/h (tram)
- Bus lanes – up to 10,000 persons/h
- Bus rapid transit – 9,000–35,000 persons/h (Transmilenio Bogotá)
- Light rail – up to 19,000 persons/h (exclusive row)
- Heavy rail – up to 49,000 persons/h

These capacities may vary under different conditions of use, but they are much greater compared to the capacities of aerial cable cars, which have maximum capacities of up to 2,000 persons/h for an aerial tramway and up to 4,000 persons/h for gondolas.

Dwell times are short for gondolas, as the cabins are small (usually 6–8 persons, maximum 30). Average dwell time for a bus of 10 people is around 22 seconds and for 30 people around 43 seconds, as noted Rexfelt et al. (2014). A problem for buses can be the times necessary for payment and validation of tickets; for cable cars, this can be done outside the vehicle before entering the platform.

## **Methodology**

Based on existing operating modes of cable cars, a geometrical model of a station was developed that included all the essential elements that affect passenger entry and exit. A CAD program was used for implementing this geometric model, with the possibility of 3D modeling. Based on the geometric model, a model was established for calculating the capacities and other properties of cable cars. The same methodology was used for new proposals of cable cars with improved characteristics. First, a geometric design that included new ideas presented in this paper (see Figures 2, 3, and 6) was implemented within the model and then was based on the establishment of a calculation model. Based on the results, the new model of cable car was compared with existing systems of passenger transport in urban environments.

## **Existing Procedures and New Models of Passenger Entry and Exit**

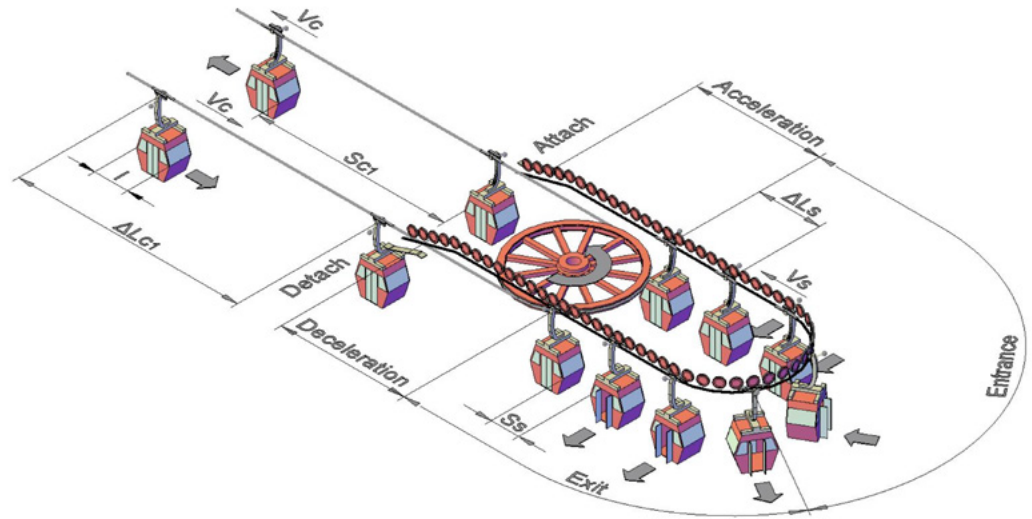
Depending on the identified limitations of cable car transport, primarily small capacity, it should be possible to increase the capacities of gondolas by using two platforms for entry and exit at stations.



### Existing System of Entry and Exit for Gondolas

The existing system for gondolas is to use only one platform for boarding (Figure 1). The vehicle has a maximum speed of 0.5 m/s, and the minimum distance between vehicles in a station is 0.5 m (CEN 2004).

**FIGURE 1.**  
Existing system of gondolas – passenger entry and exit in station



Operating gondolas with detachable grips within a station is as follows. When the vehicle is connected to the rope and located on the line, it moves with the speed of a cable car on the line ( $V_c$ ). When it comes into the station, the grip detaches from the rope, and the cabin starts to brake by using friction discs with rubber rings that touch the top of the grip. When the cabin reaches a low speed within the station ( $V_s$ ), it moves by friction conveyor through the station. The doors open and the exit starts, and then passengers enter the cabins. After the turn, when the cabin reaches the end of the platform, the doors close and acceleration begins. The grip attaches to the rope, and the cabin leaves the station at the speed of a cable car on the line ( $V_c$ ).

Calculations were made based on Težak (2012): spacing or pitch (CEN 2005) on unidirectional installations is the distance between two successive carriers, group of carriers, or tow hangers. If the length of the vehicle is 3 m and the minimum distance between vehicles in the station is 0.5 m, the minimum spacing between vehicles in the station is:

$$\Delta l_s = 3 + s_s = 3 + 0,5 = 3.5m \tag{1}$$

where,

$\Delta l_s$  = spacing between vehicles while in the station (m)

$s_s$  = distances between vehicles (cabins) in the station (m)

On the basis of the maximum speed of vehicles in the station and the minimum spacing between vehicles in the station, the minimum interval between vehicles can be calculated:

$$\Delta t_s = \frac{\Delta l_s}{V_s} = \frac{3.5}{0.5} = 7s \quad (2)$$

where,

$\Delta t_s$  = intervals between vehicles in the station (s)

$V_s$  = speeds of vehicles in the station (m/s)

As only one platform is used, the minimum intervals between vehicles in the station and on the line are the same:

$$\Delta t_s = \Delta t_c \quad (3)$$

where,

$\Delta t_c$  = interval between vehicles on the line (s)

The maximum capacity of the gondola depends on the minimum interval between vehicles and the number of persons in the vehicle. If the number of persons in the vehicle is 8, the theoretical capacity of the gondola is:

$$Q_c = \frac{3600}{\Delta t_c} \cdot n = \frac{3600}{7} \cdot 8 = 4114 \text{ persons/h} \quad (4)$$

where,

$Q_c$  = capacity of the gondola (persons/h)

However, in practice, the minimum interval of 7 s by the gondolas is not applied. Only for chair lifts and surface lifts are such small intervals used (CEN 2004). For gondolas with the highest capacities, the interval between vehicles is somewhere around 12 s. For example, a gondola in Medellin has a capacity of 3,000 persons/h, 10 persons in one vehicle, and intervals between vehicles of 12 s (Brand 2011). Gondolas with the highest capacities have cabins with several passengers and achieve maximum capacities of somewhere around 4,000 persons/h.

The described example shows that more vehicles could not be accommodated within stations, as the calculation is made based on the minimum required spacing between vehicles in the station. The spacing between the vehicles on the line depends on the relationship between the speed of the vehicles in the station and the speed on the line:

$$\Delta l_c = \frac{\Delta l_s}{V_s} \cdot V_c = \frac{3.5}{0.5} \cdot 6 = 42m \quad (5)$$

where,

$V_c$  = speeds of the cable cars - speeds of vehicles on the line (m/s)

$\Delta l_c$  = space between vehicles on the line (m)

The maximum speed for a cable car with a closed carrier (gondola) with one carrying-hauling rope is 6 m/s, which has 12 s of interval between vehicles and a space between vehicles of 72 m. If the calculated space between vehicles is lower than 42 m, then there would be insufficient space in the station between vehicles. When comparing the distances between cable cars and distances between vehicles in road transport, it can be seen that the distance of 42 m or 72 m is quite high (in cases in which vehicle speeds are low), and there are possibilities for reducing this space. Also, the interval between vehicles on the cable car line, which in this case is 7 s, is fairly high and is much greater than for transport by road.

### System with Two Platforms for Entry and Exit of Gondolas

A system with two station platforms for gondolas is shown in Figure 2. Two platforms—one internal and one external—are placed at the same level. Each platform has a separate line for vehicle braking, transporting, and accelerating, and both platforms use the same zone for detaching and attaching grips on the rope. Cabin entry into the station for both platforms is at the same place, and when it detaches from the rope, it starts braking for the internal or external platform. Cabins alternate between the internal and external platforms.

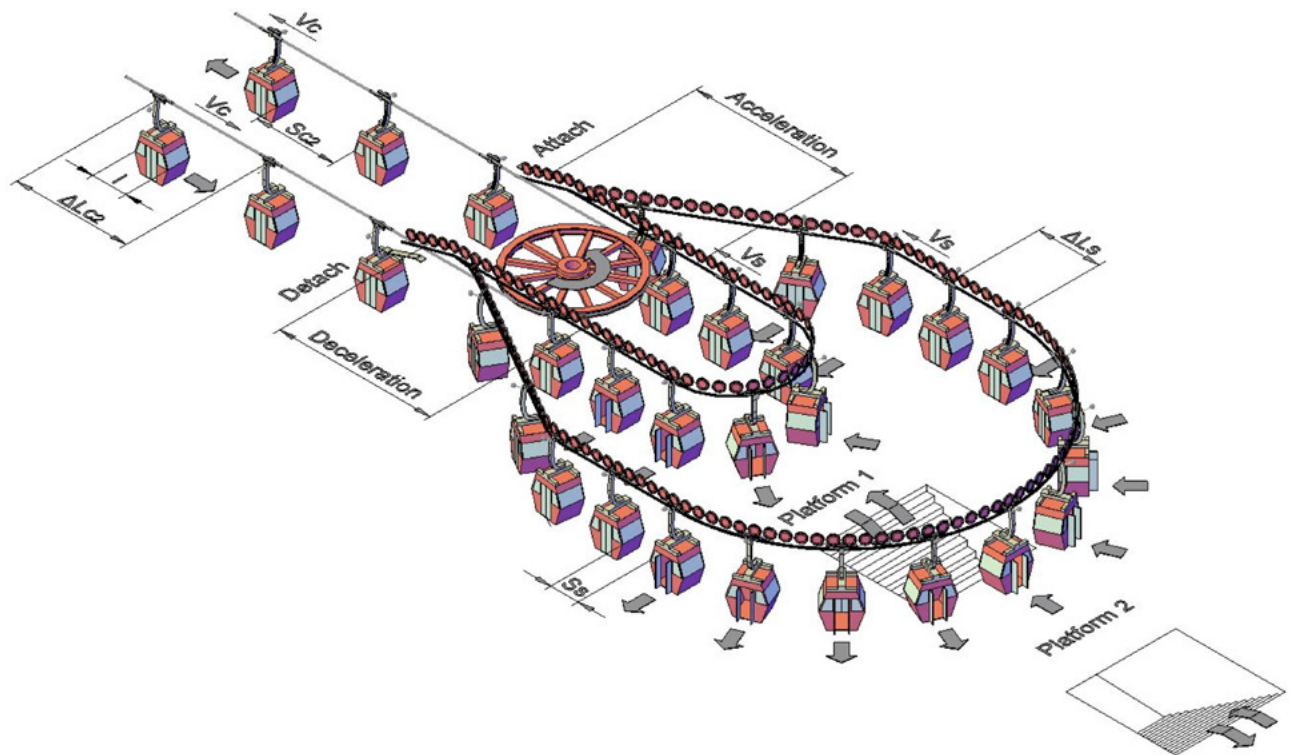


FIGURE 2. System of two gondola platforms on same level – passenger entry and exit

The procedure of entry and exit from slowly-moving cabins takes place separately at the internal and external platforms, where acceleration of the cabins is separate. Only before the zone of attaching the grips onto the rope, where the cabin has the same speed as the rope ( $V_c$ ), do the internal and external lines merge. All cabins leave the station at the same place. Passenger access to the internal platform runs through the underpass under the external platform.

This system could solve the problem of distances between vehicles that are too great on the line of the cable cars.

In this case, vehicle speeds (0.5 m/s) and minimum distances between vehicles in the station (0.5 m) are the same as in Figure 1 for the existing system of gondolas with one platform. It is also the same minimum time interval for vehicles in the station (7 s).

However, with the use of two platforms in the station, the minimum interval between vehicles on the line is reduced by twofold and at 3.5 s would already be close to the time intervals of passenger cars in road transport, which is around 2 s.

$$\Delta t_{c2} = \frac{\Delta t_s}{2} = \frac{7}{2} = 3.5s \quad (6)$$

where,

$$\Delta t_{c2} = \text{interval between vehicles on the line for gondolas with two platforms (s)}$$

It also would reduce the spaces between the vehicles on the line twofold:

$$\Delta l_{c2} = \Delta t_{c2} \cdot V_c = 3.5 \cdot 6 = 21m \quad (7)$$

where,

$$\Delta l_{c2} = \text{spacing between vehicles on line for gondolas with two platforms (m)}$$

The capacities of gondolas with two platforms in the station would be increased twofold and in this case would be:

$$Q_{c2} = \frac{3600}{\Delta t_{c2}} \cdot n = \frac{3600}{3,5} \cdot 8 = 8228 \text{ persons/h} \quad (8)$$

where,

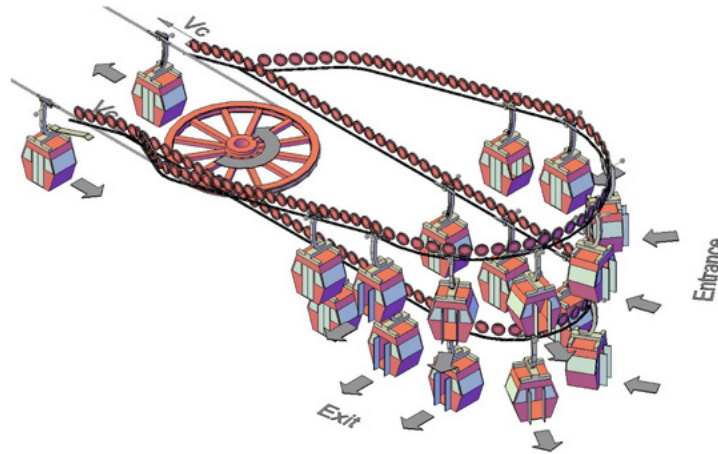
$$Q_{c2} = \text{capacities of the gondolas with two platforms (persons/h)}$$

The disadvantage of this system is that due to the larger radius of the line on the external platform, there would be a greater number of cabins, as in the internal platform, which would increase the costs of the device. Cabins would not leave the station in the same order as they entered the station. As there would be two platforms, the surface of the floor in the station would have to be much greater. This weakness could be removed by using two platforms on two different floors, as shown in Figure 3. Each floor would have separate lines for the braking, transporting, and acceleration of

cabins. In this case, the surface of the ground plan in the station would be smaller and the number of vehicles in the station less than if both platforms were on the same level (Figure 2).

**FIGURE 3.**

System of two platforms for gondola on two different floors – passenger entry and exit



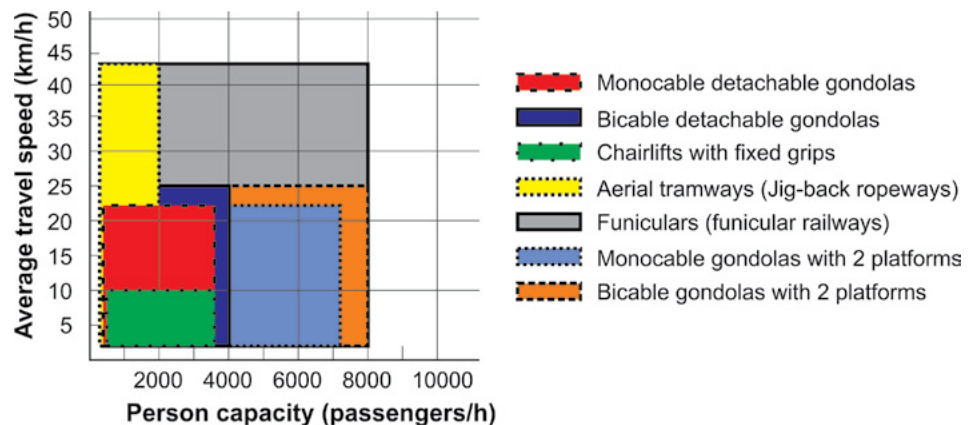
### Transportation Characteristics of Gondolas with Two Platforms

The described system of gondolas with two platforms, which would reduce the distances between vehicles on the line, could increase the capacity of cable cars twofold and, therefore, the cable cars could reach capacities of up to 8,000 persons/h. Such capacity would be comparable to the capacities of other high-performance systems designed to carry persons in public passenger transport. The top speed of such devices in relation to regulations would remain 6 m/s (21.6 km/h) for mono-cable systems and 7 m/s (25.2 km/h) for bi-cable systems.

Figure 4 shows the transportation characteristics of certain types of cable cars. The maximum speeds and capacities are achieved by funiculars, but they are not aerial cable cars and do not have the advantages of transport in the air in urban centers, where there are crowded streets. The fastest aerial cable cars are aerial tramways, but they have small capacities. Gondolas with two platforms would have double the capacity of normal existing gondolas.

**FIGURE 4.**

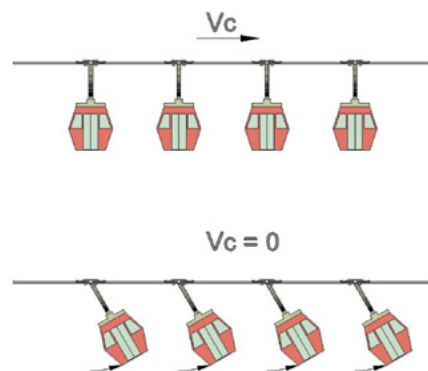
Comparison between gondolas with two platforms and other types of cable cars



A disadvantage of gondolas is also the difficulty of access for persons with disabilities and older adults because the vehicles in the station do not stop completely (as with aerial tramways or funiculars). To facilitate the entry of these passengers, it should be necessary to stop the gondola. If the gondola stops every 15 minutes, entry of persons with disabilities and older adults takes 30 seconds, and exit takes 30 seconds, the gondola stops 8 times per hour. This is 4 minutes of inactivity, which represents a 6.66% reduction in passenger capacity for gondolas.

A gondola has, by its implementation, a distinct safety advantage over a road vehicle. A sudden stop of the carrying-hauling rope will cause swaying of all cabins and the cabins will start rotating. The deceleration force would not eject passengers from the cabin (as in a car), but would work on the force of the passengers in a direction perpendicular to the ground of the rotating cabin. Therefore, there would be no collision between cabins after the sudden braking or stopping of the gondola (Figure 5).

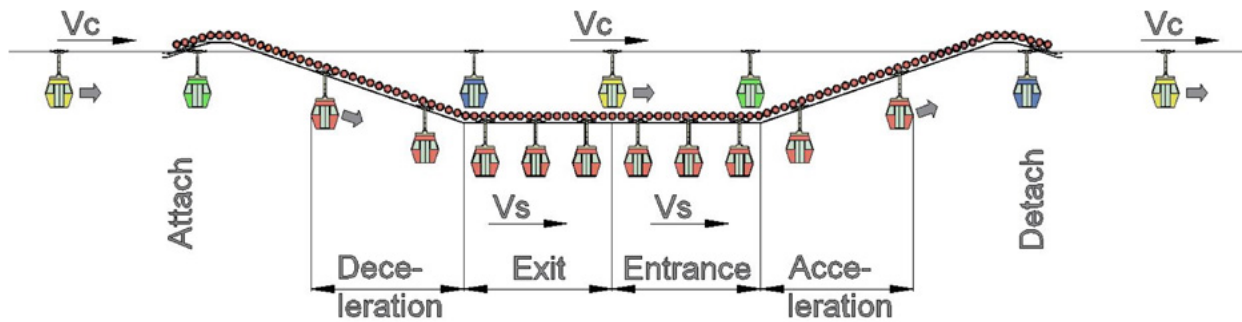
**FIGURE 5.**  
Unique swaying of vehicles  
in event of sudden stop of  
gondola



In theory, in stations, different numbers of platforms could be added, which could be placed on different floors. However, if there are too many vehicles on the line, insufficient safety distances could occur, so, in accordance with regulations (CEN 2004), longitudinal swaying of vehicles must be possible due to different effects such as impacts of wind, dynamic forces, etc.

Another advantage of gondolas is that they use small vehicles. This means that in the intermediate stations on the line, it is not necessary to stop all cabins, only those from which passengers exit. Special construction of intermediate stations, as shown in Figure 6, could allow this. Using this measure, passengers in other cabins could smoothly travel to other or final stations. Figure 6 shows that every fourth cabin detached from the rope and wheel conveyor leads it to a lower level with the speed of the rope ( $V_C$ ). Then, the grip detaches from the rope and the cabin starts braking by using friction discs with rubber rings, which touch the top of the grip. When the cabin reaches a low speed in the station ( $V_S$ , which is less than 0.5 m/s), it moves by a friction conveyor through the station. The door opens, and passenger exit and entry from/into the cabins begins. After that, when the cabin reaches the end of the platform, the door closes and then starts accelerating to the speed of the rope. The wheel conveyor leads the cabin to the higher level, where the grip attaches to the rope, and the cabin leaves the station with the speed of the rope on the line ( $V_C$ ).





**FIGURE 6.** Intermediate station that stops every fourth cabin

The advantage of such a station is that the cabin comes down to the level of the ground, which could be a street surface. The disadvantage is that more cabins in the station are necessary because they are slower-moving than other cabins on the rope. A cabin leaving the station must be attached at the same place on the rope as a cabin entering the station.

For passengers to know which cabin will be stopping at one of the intermediate stations, the cabins could be differently marked with the inscription of the intermediate station or have different colors—for example, a yellow cabin stops at the first intermediate station, green at the second, red at the third, and blue at the fourth. At the end, cabins come into the final station.

### Price Comparisons with Cable Car Systems

As stated by Clement-Werny et al. (2011), investment costs of existing mono-cable gondolas in mountain areas are as follows:

- Drive station – 3,000,000 €
- Intermediate station – 1,500,000 €
- Return station – 1,000,000 €
- Cabin (8–10 person) – 30,000 €
- Pylon – 100,000 €
- Carrying-hauling rope – 100,000 €

The cost of a mono-cable gondola with a capacity of 3,000 persons/h with 100 cabins and 20 pylons without intermediate stations would be about \$11 million US. However, this does not include the price of the land and the preparation for construction, which in urban environments can be very expensive. For example, the cost of a gondola in Maribor, which is not in an urban area, is \$13.9 million US (12.2 million €), which includes 82 cabins, 19 pillars, a drive station, a return station, and one intermediate station. The cost for gondola LINE L in Medellin (93 cabins, 20 pylons, 2 intermediate stations) is \$24 million US (Brand and Davila 2011). In Maribor, the new cable car was set up on the old site, which meant that the land was already purchased. In Medellin, a new cable car was set up at a new location in the city, which is a more expensive investment.

Thus, the average price for mono-cable gondolas per km length in Medellin for the line L was \$11.6 million US/km, and in Maribor it was \$5.5 million US/km.

Is a gondola with two platforms in the stations less expensive than the two parallel gondolas with the existing configuration in the stations? The construction characteristics of cable cars are calculated according to the maximum force on the rope, which depends of the altitude, force of friction, weight of cargo, weights of rope and empty vehicles, and tension and dynamic forces at the drive device (Nejez 2006). A disadvantage of mono-cable gondolas is that the weight of the carrying-hauling rope is quite high. The weight ratio of cargo, empty cabins, and carrying-hauling rope is somewhere around 30:30:40. So if the increase in capacity is twofold, then the increased weight of cargo, the number of cabins, and the weight of carrying-hauling rope also are twofold.

At twice the maximum tension force on the rope, the diameter of the rope has to increase by 41%, so the weight of the rope per meter doubles. The pylons need to be stronger, roller batteries would have to have sheaves with larger diameters, and the number of sheaves in the roller battery would have to be greater. The drive system of a cable car with a twofold greater capacity also would have to have double power of the electric motor. The costs for intermediate stations would be similar to existing conventional gondolas and gondolas with two platforms at the ending stations. Similarly, the cost of a drive station and a return station would not be twice as expensive.

In the end, it can be concluded that the price of gondolas with two platforms in stations would be slightly lower than for two parallel conventional gondolas. However, the gondola would have a greater impact on visual appearance in urban environments and would be better if using only one line instead of two. It is estimated that the cost for a gondola with two platforms at the ending stations, which would achieve a capacity of 6,000–8,000 persons/h, would be \$11–20 million US per km of line. Depending on the observed values of the investment costs in the public transport system, as delivered by Gardner (1996), this would be higher than the price of investment in a tramway transport system (\$5–15 million US per km), which has a similar capacity.

## **Conclusion**

Cable car transport has many advantages compared with other modes of passenger transport, such as clean electricity drive, high levels of safety for passengers, and quiet operation. The most important characteristic is that cable car transport can be installed in the air over streets in urban areas, independent of congestion. However, cable cars, in spite of the advantages, still cannot achieve certain characteristics of other modes of transport, such as capacity or number of passengers per hour.

This paper has demonstrated that cable car transport can become competitive with other types of passenger transport in urban areas. With additional platforms in gondola stations, it is possible to achieve reduced distance (intervals and spacing) between vehicles on the line and increase capacity. In this way, the necessary surfaces for passenger entry and exit in the cabins increases, which is necessary for passenger



transport with large capacities. More important, any given solution would have to take into account the existing technologies related to gondolas, such as detachable grips, acceleration and braking of cabins, and use of existing wheel conveyors that are moving vehicles through the station. The difference would be that there would be two separate platforms in the stations with systems for the braking, moving, and accelerating of cabins. Even while on the line, the same technology would be used, except the vehicles on the line would be better sorted, which would increase the efficiencies of the cable cars.

Gondolas also have advantages because of smaller vehicles. This means that at intermediate stations on a line, it would not be necessary to stop all cabins, but only those in which passengers would like to exit; other vehicles could freely travel to the other stations. Gondolas with two platforms in a station with twofold greater capacity would be more expensive but not twice as expensive as existing conventional gondolas with one platform. The price for a mono-cable gondola with two platforms in a station would be \$11–20 million US per km.

## References

- Abcde-institute.org. 2015. "Urban Ropeways. The Optimal System." [http://www.abcde-institute.org/urban\\_ropeways\\_the\\_optimal\\_system.html](http://www.abcde-institute.org/urban_ropeways_the_optimal_system.html), accessed June 5, 2015.
- Bocareo, J. P., J. P. Portilla, J. M. Velásquez, M. N. Cruz, A. Peña, and D. R. Oviedo, D.R. 2014. "An Innovative Transit System and Its Impact on Low Income Users: The Case of the Metrocable in Medellín." *Journal of Transport Geography*, 39: 49-61.
- Brand, P., and J. D. Davila. 2011. "Aerial Cable-Car Systems for Public Transport in Low-Income Urban Areas: Lessons from Medellín, Colombia." 3<sup>rd</sup> World Planning Schools Congress, Perth (WA), 4-8 July 2011, [http://r4d.dfid.gov.uk/PDF/Outputs/ESRC\\_DFID/60726\\_Brand\\_aerial.pdf](http://r4d.dfid.gov.uk/PDF/Outputs/ESRC_DFID/60726_Brand_aerial.pdf), accessed June 18, 2015.
- Brida, J. G., M. Deidda, and M. Pulina. 2014. "Tourism and Transport System in Mountain Environments: Analysis of the Economic Efficiency of Cableway in South Tyrol." *Journal of Transport Geography*, 36: 1-11.
- CEN (European Comitee for Standardization). 2004. "EN-12929-1. Safety Requirements for Cableways Installation Designed to Carry Persons – General Requirements – Part 1: Requirements for All Installations." CEN/TC 242, Brussels.
- CEN (European Comitee for Standardization). 2005. "EN-1907, Safety Requirements for Cableways Installation Designed to Carry Persons – Terminology." CEN/TC 242, Brussels.
- Clement-Werny, C., D. Dubois, A. L. Ruyet, M. Potier, S. Rousic, and Y. Schneider. 2011. "Aerial Ropeways as Urban Transport Systems." Certu-STRTMG-CETE, [http://www.strmtg.developpement-durable.gouv.fr/IMG/pdf/cableways\\_MEDDLT\\_december2011.pdf](http://www.strmtg.developpement-durable.gouv.fr/IMG/pdf/cableways_MEDDLT_december2011.pdf), accessed June 5, 2015.

- Dávila, J. 2013. "Urban Mobility and Poverty: Lessons from Medellín and Soacha, Colombia." London, DPU, UCL and Universidad Nacional de Colombia, <http://www.bartlett.ucl.ac.uk/dpu/metrocables/book/english>, accessed June 24, 2015.
- Doppelmayr, A. 1997. *Denkastosse zur Funktionseerfülung von Einseilumlaufbhnen, Projektirung und Konstruktion im Sicherheitsregelkreissystem, basoerend auf der Aanalyse von Vorfällen*. ISBN 3-9500815-0-X, Wolfurt, Austria.
- Gardner, G. 1996. "Decision Making and Infrastructure Projects." VII Conference on Urban Transport and Integrated Development, New Delhi, February 1996, [http://www.transport-links.org/transport\\_links/filearea/documentstore/249\\_PA3143\\_1996%5B1%5D.pdf](http://www.transport-links.org/transport_links/filearea/documentstore/249_PA3143_1996%5B1%5D.pdf), accessed June 18, 2015.
- Günthner, W.A. 1999. *Seilbahntechnik*. Technische Universität München, München.
- Heinrichs, D., and J. S. Bernet. 2014. "Public Transport and Accessibility in Informal Settlements: Aerial Cable Cars in Medellín, Colombia." *Transportation Research Procedia* 4: 55-67.
- ISR - Internationale seilbahn-rundschau. (2015). "Größtes urbanes Seilbahnnetz komplett," 1 -18.
- Nejez, J. 2006. *Vorlesung aus Seilbahnbau*. Technische Universität Graz, Graz
- Nikšić, M., and S. Gašparović. 2010. "Geographic and Traffic Aspects of Possibilities for Implementing Ropeway Systems in Passenger Transport." *Promet Traffic & Transportation*, 22 (5): 389-398.
- Oplatka, G. 2008. "Seilbahnen – sicheres Verkehrsmittel in den Bergen – Wohin die technischen Trends gehen In." *NZZ Online*, <http://www.nzz.ch/lebensart/automobil/die-vielen-gesichter-der-seilbahn-1.832644>, accessed June 5, 2015.
- Rexfelt, O., T. Schelenz, M. Karlsson, and A. Suescun. 2014. "Evaluating the Effect of Bus Design on Passenger Flow: Is Agent-Based Simulation a Feasible Approach?" *Transportation Research Part C: Emerging Technologies*, 36: 1-11.
- Sever, D. 2002. "Some New Methods to Assure Harmonisation of Sustainable Development of Mountain Resorts Ropeway." *Promet* 14 (5): 213-220.
- Težak, S. 2012. "Modern Cableways – The Base of Mountain Sports Tourism, Strategies for Tourism Industry – Micro and Macro Perspectives." Dr. Murat Kasimoglu (ed.), DOI 10.5772/38541, <http://www.intechopen.com/books/strategies-for-tourism-industry-micro-and-macro-perspectives/modern-cableways-the-base-of-mountain-sports-tourism>, accessed June 6, 2015.
- Tirachini, A. 2013. "Estimation of Travel Time and Benefits of Upgrading the Fare Payment Technology in Urban Bus Service." *Transportation Research Part C: Emerging Technologies*, 30: 239-256.
- Transportation Research Board. 2003. *Transit Capacity and Quality of Service Manual*, 2nd Edition, [http://www.trb.org/Main/Blurbs/Transit\\_Capacity\\_and\\_Quality\\_of\\_Service\\_Manual\\_2nd\\_153590.aspx](http://www.trb.org/Main/Blurbs/Transit_Capacity_and_Quality_of_Service_Manual_2nd_153590.aspx), accessed June 8, 2015.

Wu, H., X. W. Wu, H. Q. Huang, and H. J. Wang. 2013. "The Role and Development Prospects in the Ropeway in Urban Transport System, Resources and Sustainable Development." PTS 1-4, Book Series: *Advanced Materials Research*, 734-737: 1641-1644.

### **About the Authors**

**SERGEJ TEŽAK** (*sergej.tezak@um.si*) is an Assistant Professor at the University of Maribor, Faculty of Civil Engineering, Transportation Engineering and Architecture, Department of Transportation Engineering, where he studies and teaches about quality management in public transport, cableway transport, and geometric modeling.

**DRAGO SEVER** (*drago.sever@um.si*) is an Associate Professor of traffic technique and transportation technology and Chair of the Transportation Technology and Organisation, Faculty of Civil Engineering, Transportation Engineering and Architecture, University of Maribor. His areas of interest include transportation technology, public transport, and cableway transport.

**MARJAN LEP** (*marjan.lep@um.si*) is an Assistant Professor of traffic planning and modeling and transport informatics and head of the Department of Transportation Engineering, Faculty of Civil Engineering, Transportation Engineering and Architecture, University of Maribor.

---

# Trends, Causal Analysis, and Recommendations from 14 Years of Ferry Accidents

Abigail S. Golden and Roberta E. Weisbrod  
Worldwide Ferry Safety Association

---

## Abstract

*Ferries and other passenger vessels provide a crucial mode of transportation for many in the developing world, especially in archipelagic nations like Indonesia and in river delta nations like Bangladesh. However, this dependence on passenger vessels coincides with a high rate of accidents and fatalities in many countries, linked to purchase of old, substandard, and/or inappropriate vessels in low-income nations; overcrowding; inadequate training; and sudden hazardous weather. Any serious attempt to decrease the number and fatality count of ferry accidents in the developing world must have a complete record of past incidents on which to draw. This report compiles detailed information on the 232 major accidents that occurred around the world between 2000 and 2014. It assesses the prevalence of various common factors in ferry accidents, including human error, hazardous weather, and overcrowding, and makes recommendations for future research into the prevention of ferry accidents.*

**Keywords:** Ferry safety, maritime safety, accident causation, fatalities

## Introduction

Although ferries offer a safe and often a discretionary form of transportation in North America and Europe, this is far from the case in the developing world. Many countries in Southeast Asia, the African Great Lakes region, and elsewhere rely on ferries as a primary mode of transportation for people and goods, and accidents are frequent. This high rate of accidents and fatalities is linked to a number of causes, including substandard vessels, overcrowding, and a lack of training for emergency scenarios, as well as to more systemic issues such as inadequate support and/or corruption in the regulatory process. These failures were highlighted by the 2014 sinking of the MV Sewol off the coast of South Korea, during which the captain and crew abandoned ship while hundreds of students remained aboard and perished (Harlan 2014).

Efforts to monitor, let alone improve, ferry safety in the developing world are handicapped by incomplete recordkeeping in many developing countries and sparse or

non-existent media coverage of accidents by major international news outlets. Reports of ferry accidents often do not include the name of the vessel involved, information on the company or individual that owned the vessel, or data about proximate and root causes of the accident. Often, even the number of passengers on the ferry is unknown, because overcrowding is massive, disturbingly frequent, and unrecorded (Lawson and Weisbrod 2005).

Any serious attempt to decrease the number and fatality count of ferry accidents in the developing world—as Interferry, the International Maritime Organization, and the Worldwide Ferry Safety Association have pledged to do—must have a complete record of past incidents on which to draw. This project works to fill in the gaps of an existing dataset of ferry accidents compiled by Interferry and the Worldwide Ferry Association, spanning 232 accidents in the period between 2000 and 2014. With this information, it is possible to analyze trends and common threads among accidents and make recommendations for future safety efforts.

## **Methods and Sources**

Information in the dataset was drawn from news sources around the world, both local and international; incident investigation reports, where available; and the IMO Global Integrated Shipping Information System (GISIS). Particularly well-represented news sources include the BBC and the English-language version of China's Xinhua News Agency, both of which cover accidents around the world. Only accidents that resulted in the deaths of two or more passengers and/or crewmembers were recorded. Each accident entry includes, where available, number of fatalities compared to total passenger load; date, location, and time of day of the accident; proximate cause and any exacerbating factors; name of vessel(s) involved, with their operators and owners; weather conditions; captain and crew member response; and the timing and effectiveness of search and rescue efforts, if any. In total, 25 data fields were collected across the 232 entries.

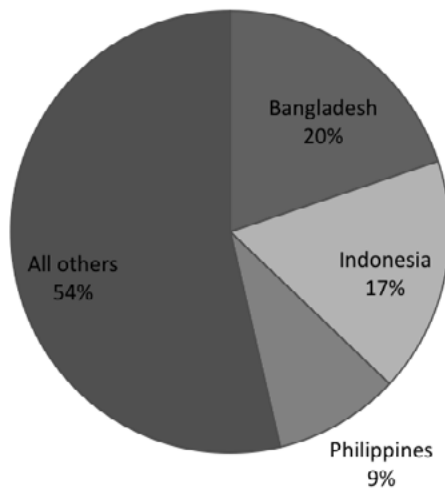
In many entries, one or more of the desired metrics is missing, reflecting incomplete media reporting of ferry accidents, complex and multilayered accident causes, and a lack of reliable accident investigation. However, the lack of records about these factors can itself be considered an important data point in the understanding of ferry accidents, since it indicates poor recordkeeping and accident investigation in those countries. Therefore, the existence of a number of incomplete accident records at the conclusion of this project should not be taken as a sign of the project's failure, but as another form of information about ferry safety in the countries studied.

The analysis of accident causes presented below would be much more valuable if we had access to full-length investigation reports for all, or even most, of the cases described here. With detailed reports, we would be able to tease out the interacting technical, organizational, and human factors leading to fatal accidents through a model such as SEMOMAP (SEquential MOdel of the MARitime Process), used by Nurwahyudy (2014) to determine the causes and contributing factors of selected Indonesian ferry

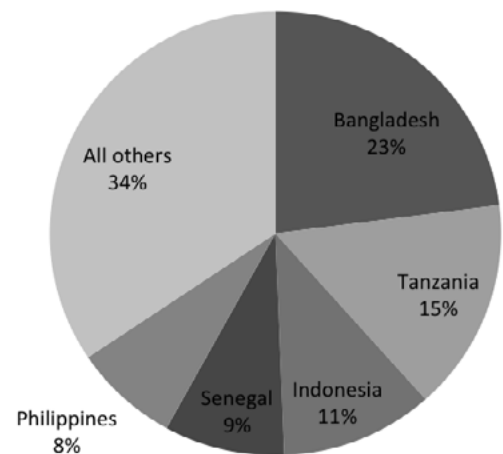
fires. However, in most of the countries in which ferry accidents are rampant, either accident investigations are not carried out or their results are never published.

### Analysis

This paper records the details of 232 ferry accidents over the 14-year period from 2000 to 2014. By a conservative tally based on news reports, 21,574 lives were lost, an average of 130 deaths per incident and 1,541 deaths per year. The accidents included occurred in 43 different countries around the world, with three countries—Bangladesh, Indonesia, and the Philippines—responsible for almost 50% of all accidents (Figure 1). Even more striking, the five countries of Bangladesh, Tanzania, Indonesia, Senegal, and the Philippines were responsible for almost two-thirds of all fatalities in the 14-year period (Figure 2). Bangladesh alone had 20% of all accidents in the time period and 23% of all fatalities. Overall, 94% of all accidents and 97% of all fatalities occurred in developing-world countries, using the World Bank’s definition of developing-world nations as those with a gross national product per capita of less than \$12,736 (World Bank 2015).



**FIGURE 1.**  
Proportion of ferry accidents occurring in top 3 countries



**FIGURE 2.**  
Proportion of ferry fatalities occurring in top 5 countries

### Human Error

Human error, also known as operator error, is recognized as a frequent cause of accidents and mishaps across many industries. It can include a variety of faults, including errors of commission, in which an operator performs an act incorrectly; errors of omission, in which the act is forgotten or left out; errors of timing, in which the act is performed too early or too late; and errors of sequence, in which acts are performed in the wrong order (Latino 2007). Conventional wisdom, cited by many authors, holds

that some form of human error causes about 80% of maritime vessel accidents, but this number has not been put to the test of a rigorous quantitative analysis, especially for passenger vessels (Rothblum 2000). The 14-year dataset compiled for this paper provided the opportunity to run an analysis of the role of human error across more than 200 ferry accidents around the world.

One challenge to this study was the concern that human error can be difficult to define and recognize after the fact, especially when using sparse news reports written by non-technical personnel who may not have had access to the scene of an accident. To address this issue, two analyses have been run on all accidents in the dataset, one defined by conservative parameters and one by liberal parameters for what may constitute human error. For each analysis, we determined the percentage of all accidents attributable to human error and the percentage of all fatalities attributable to human error.

Under conservative parameters, human error includes only those errors that led directly to the incident in question. Vessel disrepair and misjudgments about the safety of sailing during bad weather would not qualify. Human error that led to increased fatalities, but not the incident itself, would not count (i.e., failure to provide passengers with life vests). Overloading of passengers, unbalanced rolling cargo, and collisions with other vessels are classic examples of human error under these conservative conditions.

Under liberal parameters, criteria are as broad as possible. Factors such as misjudgment of the weather and vessel disrepair qualify as human error under this analysis. Human error leading to increased fatalities (as defined above) qualifies. Overloading that is not borne out by hard numbers on the number of passengers versus vessel capacity will count under this analysis but not the conservative one.

In both scenarios, we have disregarded incidents caused by malicious damage, most notably the 2004 SuperFerry bombing by an Islamist terrorist group in the Philippines. Cases in which human error on the part of passengers, rather than crew, caused accidents also were included under both conservative and liberal parameters; this includes incidents such as the sinking of the Acita 03 in Indonesia in 2007, which was precipitated by passengers climbing onto the roof of the vessel to get a stronger cellphone signal (Mandari 2007). Cases for which the cause of the accident is unknown have not been included in either analysis; these accounted for 14% of the total dataset.

This analysis demonstrated that 53% of all accidents in the dataset were caused by human error under conservative parameters, and 74% were caused by human error under liberal parameters. However, when accidents possessing incomplete causal data were removed from the analysis, it was found that a higher proportion of accidents were related to human error—62% under conservative measures and 86% under liberal measures. Of the dataset's 21,574 fatalities, 70% were related to human error under our conservative criteria, and under liberal criteria, 86% of the lives lost were linked to human error. When accidents with incomplete causal data were ignored, 75% of fatalities were found to be caused by human error under conservative criteria, and an overwhelming 92% could be linked to human error under liberal criteria.



Table 1 is a summary of results of the accident analysis of 147 ferry accidents worldwide to determine what proportion of accidents are caused by human error (HE). "Total cases" refers to all cases included in the dataset, including those in which no cause could be assigned. "Total known" refers to only those cases in which a cause (human error/no human error) was assigned.

**TABLE 1.**  
Summary of Results of  
Human Error  
Ferry Accident Analysis

	Conservative	Liberal
<b>Number of Accidents</b>		
% HE* by total known cases	61	85
% HE by total cases, known and unknown	53	73
% unknown	14	14
<b>Fatalities (dead and missing)</b>		
# fatalities caused by HE	15,156	18,595
% fatalities caused by HE by total known cases	75	92
% fatalities caused by HE by total cases, known and unknown	70	86

\*HE = human error

### **Weather**

Hazardous weather conditions are a major cause of fatalities and vessel loss while at sea. High winds together with rough seas and high waves have caused vessels that had previously been traveling safely and stably to become destabilized and capsize. Numerous ferry fatalities have been associated with sudden hazardous weather, as have the loss of fishing vessels and their crew, cargo vessels, and even the largest military ships, known as super carriers (Lehner and Rosenthal 2006). Of the 232 accidents covered by this study, 50% were at least partially caused by hazardous weather, unsafe wave conditions, monsoon-related flooding, or unusually strong currents.

One example is the Philippines ferry Princess of the Stars, which set sail on June 28, 2008, as Typhoon Fengshen was making landfall in the eastern Philippines. The vessel was allowed to sail because its route would take it only through the projected periphery of the Category 3 storm, and the Princess of the Stars was considered large enough to remain afloat under those conditions. However, Typhoon Fengshen unexpectedly changed course on June 21, placing the ferry directly in its path (Yahoo! News 2008). The vessel capsized in the midst of the storm off the coast of Romblon Island at around midday on June 21, leading to a final death toll of 814 dead and missing with only 56 known survivors. Rescue vessels did not reach the wreck until 24 hours after the accident, since the area was surrounded by "gigantic waves, pounding rain, and gusty winds" (Guinto 2008).

### **Overcrowding and Overloading**

Many ferry operators, constrained by artificially low ticket prices imposed by government regulation (Lawson and Weisbrod 2005), deliberately overload vessels with passengers and cargo to cover their costs and turn a profit. Often, operators do not record the names of passengers who embark after a vessel's capacity has been reached, making it difficult to gauge the total number of dead and missing and to



identify individuals who are lost. Overcrowding can precipitate accidents, especially when passengers group themselves on the upper levels of a ferry or rush to one side when they anticipate danger. Heavy cargo loads can become destabilized if they are not stowed properly and can pose even more immediate risks if a vessel is carrying dangerous or flammable substances. In all, overloading and overcrowding played a role in about a third (29%) of the accidents collected in this database, although they rarely caused accidents alone without the influence of other factors.

### ***Other Causes***

Collisions and other navigational problems, including abrupt turns and groundings, were implicated in 22% of all accidents. Fires and engine trouble were at least the partial cause of 26 accidents, or 11% of the total dataset. Recent studies have shown that truck ferry fires are becoming a serious issue worldwide because of certain vessel design features of RO-RO truck ferries (Nurwahyudy 2014, Moretti 2015). Of the accidents for which data on the time of day could be collected, 60% occurred during the night or at dawn, when visibility is low and crewmember alertness suffers. However, this temporal information was available for less than half of all the accidents in the dataset, so this result should not be assumed to be conclusive.

## **Discussion and Recommendations**

The concentration of accidents in the Southeast Asian nations of Bangladesh, Indonesia, and the Philippines suggests that research and advocacy efforts should be focused in these three countries and the surrounding region. Bangladesh, in particular, with its high accident rate and even higher proportion of fatalities, should be considered a “hot spot” for ferry accidents and receive aid proportionate to its need. These three countries and their neighbors all experience the challenge of a regular monsoon or rainy season that creates dangerous conditions in waterways and puts stress on maritime infrastructure. In addition, they all score below the 50<sup>th</sup> percentile for control of corruption in the World Bank’s Worldwide Governance Indicator tool, a dataset used to summarize the quality of governance provided in countries around the world (World Bank 2014). New research and new ideas are urgently needed to combat these risk factors; nearly 9,000 lives have already been lost to accidents in those three countries alone.

### ***Human Error***

The widespread occurrence of human error—a factor in more than 70% of accidents, by the liberal criteria described above—highlights the need for better and more intensive training programs for captains and crew, along with intuitive, low-cost technologies to help crew members monitor and control hazardous conditions. Cases in which error occurred at the hands of passengers, such as the Acita 03 disaster mentioned previously, show that safety training must extend to passengers as well, following the model of the airplane safety instructions currently given at the beginning of every flight. More broadly, the safety culture of countries and companies—defined most simply as the basic assumptions of an organization about how safety issues should be treated (Guldenmund 2000)—must be strengthened. Although government agencies can have a role in defining and changing an industry’s safety culture from the top down,

individual companies, ferry operators, and trade associations are powerfully placed to improve their organizations' safety standards on their own. Operators also have the most to lose from poor safety standards, since it is their passengers, crew, vessels, and company reputation that are most at risk. They also have the most to gain from improved standards, since passengers with higher confidence in the industry will take more trips and spend more money on travel.

### ***Weather***

Encountering storms and unsafe weather conditions will always pose an unavoidable risk when traveling by water. That said, simultaneously improving weather information systems and making them more affordable for small business owners in the ferry industry could prevent accidents and save thousands of lives. The Princess of the Stars' tragic encounter with Typhoon Fengshen in the Philippines clearly illustrates this need for better information systems, but greater changes also must happen. A culture of caution, strong maritime regulation, and concern for safety rather than profits would have prevented the sailing of the Princess of the Stars entirely; this decision would have saved the lives of the 800 men, women, and children trapped on board. A Board of Marine Inquiry convened after the accident found Sulpicio Lines, owner of the Princess of the Stars, liable for negligence in the accident and recommended that its license be suspended (Cebu Daily News 2008). But within a year, the company resumed operations under the name Philippine Span Asia Carrier Corporation, and its vessels have since been involved in other deadly accidents (Quiano and Hackney 2013). Only regulatory changes can prevent deaths in weather-related accidents as long as companies such as Sulpicio Lines push their crewmembers to maximize profits by sailing in marginal conditions.

Along with regulatory changes, a number of technological fixes that change the way weather information is disseminated could have a profound impact on ferry passengers' safety from adverse weather. Many parts of the world, especially those in which ferries are most vulnerable to sudden weather-related hazards, lack an affordable, real-time weather alert system for vessels that have already left port. One solution is the use of SMS technology to push storm alerts from a central source to crew member cellphones, a solution that already has been developed to aid fishermen in the African Great Lakes region (Luganda 2012) and Bangladesh (UNDP 2015). If expanded to include ferry operators and crews, these programs could provide great benefits to passenger ferry systems. However, even if SMS-based alert programs were initiated in the nations that need them most, the detailed and up-to-date weather data they would require could be prohibitively expensive for developing countries to obtain. In these countries, deploying a nation-wide network of the 3D-printed weather monitors currently being developed by USAID and NOAA (Freitag 2015) could alleviate some of the cost and difficulty associated with gathering data on which to base forecasts.

Finally, the prevalence of sudden hazardous weather conditions means that hyperlocal, up-to-the-minute weather data and forecasts should be a critical priority. NOAA's mobile-based weather data crowdsourcing application, called mPING (Meteorological Phenomena Identification Near the Ground), could help weather services in

infrastructure-poor countries supplement their existing monitoring systems to capture hyperlocal data.

### **Overloading and Overcrowding**

Overloading and overcrowding will continue to pose a persistent problem as long as some regulators enforce low ticket prices and fail to prevent operators from packing passengers onto their vessels. However, several factors could help mitigate this problem even without more consistent regulation and the intensive enforcement it would require. Several technologies exist to count individuals as they pass an entry point and alert staff members after capacity has been reached, although these systems cannot always take into account the extra weight of infants and hand-held baggage. A weight-sensing system of the kind used in elevators could overcome this hurdle, and an accompanying alarm that is triggered when weight limits are reached could prevent ships from sailing until the extra load is removed (Rahman and Rosli 2014).

Another unexplored factor is the role of passengers in controlling and preventing the overloading of the vessels they use. Passengers often crowd onto a vessel that is already past capacity, fearful of missing an infrequent passage to their destination but unknowingly contributing to the instability the vessel. But passengers in dangerously overcrowded situations have also been known to act collectively to avoid accidents. In May 2013, passengers on a Hong Kong ferry prevented the vessel's departure when they noticed that unsecured cargo was blocking the ferry's exits and stairway (Ngo 2013). The ferry was on the same route and belonged to the same company as another vessel that had sunk a year previously, killing 39 passengers. It is unlikely that the Hong Kong passengers would have been so active in their own defense without the example of the previous year's accident, but their reaction shows what passengers can accomplish when they act collectively.

### **Search and Rescue**

Following the compilation of the data presented here, the U.K.-based International Maritime Rescue Federation (IMRF) performed a follow-up research project analyzing the search and rescue (SAR) response in 160 of the above accidents. For each of those accidents, the IMRF's project collected data on SAR response times, the resources available to SAR services in each case, rates of rescue, and challenges during the rescue process. With these data, IMRF researcher Kiersten Reid Sander identified SAR challenges and initiatives unique to each country represented in the dataset. The five most fatality-prone countries in the world as described above—Bangladesh, Tanzania, Indonesia, Senegal, and the Philippines—have several challenges in common. They have large rescue areas but inadequate rescue and salvage equipment, which, combined with dangerous weather and sea state conditions, can cost SAR services hours of delay in reaching accident sites. In these countries, passenger vessels often fail to complete their passenger manifests, making it difficult for SAR services to gauge the time and resources they will need for a rescue. Many vessels do not carry communications devices, meaning SAR coordinators may not receive distress signals in time for their efforts to be effective (Reid Sander 2015). These challenges are systematic, and some, such as large rescue areas and poor weather, are unavoidable. But updating high-risk nations' rescue equipment,

incentivizing operators to keep accurate passenger manifests, and supplying all vessels with basic distress beacons are a set of quick fixes that could have tangible impacts for the ferry passengers caught in deadly accidents.

## Implications

The development of this dataset has already had real-world implications for ferry safety efforts. As mentioned, the IMRF contributed a follow-up project based on this work that explicated the failures and needs of SAR services in developing countries. In addition, on learning that hazardous weather played a role in 50% of accidents, the Worldwide Ferry Safety Association (WFSA) recalibrated its programming to reflect the importance of weather and included a panel on cutting-edge weather information technology at the first annual WFSA conference in 2015. This panel led to a conversation among international weather experts that resulted in the technological recommendations described in the discussion above. In 2016, WFSA will follow up with a second annual conference that will continue to draw on this dataset to direct the conference's programming.

## Conclusion

None of the causes and contributing factors of ferry accidents described are insoluble problems. Developing new rigorous but affordable training and qualification programs can address the problem of human error, and improved weather information systems can help vessels avoid storm systems, high sea state conditions, and other inclement weather. The practice of collecting passenger lists is already designed to prevent overcrowding, and new technology could help enforce caps on the number of passengers a vessel can carry. Finally, passengers can be empowered to make safe, informed decisions about their travel, enforcing safety regulations from the bottom as well as from above. Across the board, the question continues to be, not how to develop solutions to worldwide safety problems, but how to make those solutions available to ferry operators and to passengers in the countries that need them the most.

## References

- Aravilla, J. 2002. "Captain of Burned M/V Maria Carmela Ferry Cries Arson." *Philippine Headline News Online*. April 23. <http://www.newsflash.org/2002/04/hl/hl015571.htm>.
- Cebu Daily News. 2008. "License for Suspension." *Inquirer.net*. August 28. <http://globalnation.inquirer.net/cebudailynews/news/view/20080827-157097/License-for-suspension>.
- Freitag, H. 2015. "How 3D Printing Can Help Save Lives." *USAID Impact Blog*. March 16. <https://blog.usaid.gov/2015/03/how-3d-printing-can-help-save-lives/>.
- Guinto, J. 2008. "Ferry Carrying over 800 Sinking in Storm—Officials." *Inquirer.net*. June 22. <http://www.inquirer.net/specialfeatures/typhoonfrank/view.php?db=1&article=20080622-144117>.

- Guldenmund, F. W. 2000. "The Nature of Safety Culture: A Review of Theory and Research." *Safety Science* 34: 215-257.
- Hancock, P. 2014. "Norman Atlantic." *Shipwreck Log*. December 29. <http://www.shipwrecklog.com/log/2014/12/norman-atlantic/>.
- Harlan, C. 2014. "South Korean President Says Ferry Captain's Actions 'Tantamount to Murder.'" *Washington Post*. April 21. [http://www.washingtonpost.com/world/asia\\_pacific/south-korean-president-says-ferry-captains-actions-tantamount-to-murder/2014/04/21/5936bd36-c93c-11e3-a75e-463587891b57\\_story.html](http://www.washingtonpost.com/world/asia_pacific/south-korean-president-says-ferry-captains-actions-tantamount-to-murder/2014/04/21/5936bd36-c93c-11e3-a75e-463587891b57_story.html).
- Latino, R. J. 2007. "Defining and Reducing Human Error." *Briefings on Patient Safety*. November: 6-7, 12. [http://www.reliability.com/healthcare/articleshpc/nov\\_07\\_Defining%20and%20Reducing%20Human%20Error.pdf](http://www.reliability.com/healthcare/articleshpc/nov_07_Defining%20and%20Reducing%20Human%20Error.pdf).
- Lawson, C. T., and R. Weisbrod. 2005. "Ferry Transport: The Realm of Responsibility for Ferry Disasters in Developing Nations." *Journal of Public Transportation* 8(4): 17-31.
- Lehner, S., and W. Rosenthal. 2006. "Investigation of Ship and Platform Accidents due to Severe Weather Events: Results of the MAXWAVE Project." *Proceedings of the International Conference on Offshore Mechanics and Arctic Engineering*, Paper No. OMAE2006-92414: 753-760.
- Luganda, P. 2012. "SMS weather Alerts Boost Safety for Lake Victoria Boatmen." *Thomson Reuters Foundation*. June 26. <http://www.trust.org/item/?map=sms-weather-alerts-boost-safety-for-lake-victoria-boatmen>.
- Mandari, P. 2007. "At least 31 dead as Indonesian ferry sinks." *Mail & Guardian*. October 19. <http://mg.co.za/article/2007-10-19-at-least-31-dead-as-indonesian-ferry-sinks>
- Moretti, P. 2015. "Mitigating Risk on RO-RO Pax Ship." Presentation at the 2015 Interferry Conference, Copenhagen, Denmark, October 6.
- Nurwahyudy, A. 2014. "Contemporary Issues in Domestic RO-RO Passenger Ferry Operation in Developing Countries." M.S. dissertation, World Maritime University, Malmö.
- Quiano, K., and D. Hackney. 2013. "38 Dead, 82 Unaccounted for after Philippines Boat Collision." CNN. [http://www.cnn.com/2013/08/16/world/asia/philippines-ships-collision/index.html?hpt=wo\\_c2](http://www.cnn.com/2013/08/16/world/asia/philippines-ships-collision/index.html?hpt=wo_c2).
- Rahman, N. S. F. Abdul, and H. Z. Rosli. 2014. "An Innovation Approach for Improving Passenger Vessels Safety Level: Overload Problem." *International Journal of Business Tourism and Applied Sciences* 2(2): 61-74.
- Reid Sander, K. 2015. "Ferry Accidents: the Challenges of Rescue, 2000–2014." International Maritime Rescue Federation. <http://www.international-maritime-rescue.org/index.php/qgm-papers-download/file/989-search-rescue-response-to-ferry-accidents-common-problems-potential-solutions-good-practice-by-kiersten-sander>.

- Rothblum, A. M. 2000. "Human Error and Marine Safety." Paper presented at the National Safety Council Congress and Expo, Orlando, FL, Oct. 13-20. [http://www.bowles-langley.com/wp-content/files\\_mf/humanerrorandmarinesafety26.pdf](http://www.bowles-langley.com/wp-content/files_mf/humanerrorandmarinesafety26.pdf).
- United Nations Development Programme in Bangladesh. "Comprehensive Disaster Management Programme." Accessed November 30, 2015. [http://www.bd.undp.org/content/bangladesh/en/home/operations/projects/crisis\\_prevention\\_and\\_recovery/comprehensive-disaster-management-programme.html](http://www.bd.undp.org/content/bangladesh/en/home/operations/projects/crisis_prevention_and_recovery/comprehensive-disaster-management-programme.html)
- World Bank. 2015. "New Country Classifications." World Bank Data, July 2. <http://data.worldbank.org/news/new-country-classifications-2015>.
- World Bank. 2014. "Worldwide Governance Indicators." <http://info.worldbank.org/governance/wgi/index.aspx#reports>.
- Yahoo! News. 2008. "28 Philippines Ferry Survivors Found: Report." June 22. [http://web.archive.org/web/20080626173627/http://news.yahoo.com/s/afp/20080622/wl\\_asia\\_afp/philippinesweatherstormferry](http://web.archive.org/web/20080626173627/http://news.yahoo.com/s/afp/20080622/wl_asia_afp/philippinesweatherstormferry).

## **About the Authors**

**ABIGAIL S. GOLDEN** ([abigolden@gmail.com](mailto:abigolden@gmail.com)) is a research assistant at the Worldwide Ferry Safety Association. She has a bachelor's degree in environmental biology from Columbia University.

**ROBERTA E. WEISBROD**, Ph.D., is the Executive Director of the Worldwide Ferry Safety Association ([ferrysafety@gmail.com](mailto:ferrysafety@gmail.com)), which she co-founded with Len Roueche. Her research interests include water-related transportation (passenger and freight), environmentally-sound urban freight transportation, and waterfront development. She also is the director of Sustainable Ports, a business dedicated to improving the public and private benefits of maritime transportation. Previously, she was Director for Sustainable Transportation at INFORM, an environmental organization; Director for Port and Intermodal Planning at the New York City Economic Development Corporation; and special assistant to the Commissioner for Harbor Environmental Issues at the New York State Department of Environmental Conservation. She has a Ph.D. in biochemistry from Cornell University Medical College and did post-doctoral research at Rockefeller University and has taught at Columbia College, Yeshiva University, and NYU Poly (Brooklyn Polytechnic).



---

# Exploring Diversified Performance Indicators for Evaluating Non-Urbanized Transit Program Outcomes

Eunice V. Akoto, Ph.D.  
Henderson State University

---

## Abstract

*Non-urbanized (rural) transit goals include the ability to use available government funds to provide adequate and efficient transportation services while increasing mobility and accessibility. However, outcomes of these goals cannot be examined exclusively with the “traditional” transit performance indicators that are more conducive to urban systems. This study explores diversified indicators—namely, efficiency, effectiveness, and mobility constructs for evaluating program outcomes of non-urbanized transit systems—using Mississippi’s Section 5311 program as the case. The study examined how Section 5311 providers met their program goals during the implementation of the Safe, Accountable, Flexible and Efficient Transportation Equity Act—A Legacy for Users (SAFETEA-LU) using paired sample t-tests and time-series with linear trend analysis. The results suggest that mobility indicators better communicate positive outcomes of transit goals within the unique rural transit environment. Using service characteristics data as mobility indicators to supplement the traditional performance reporting may motivate continuous investment in non-urbanized transit programs at different levels government.*

**Keywords:** Public transit performance indicators, mobility, efficiency, effectiveness, policy implementation, rural transit environment

## Introduction

Performance evaluation is one of the tools used to substantiate the existence of many public programs. Performance measures are used “to evaluate, control, budget, motivate, promote, celebrate, learn, and improve” (Behn 2003, 586). Thus, organizations must identify the important indicators that work for their specific purposes. In the case of many public and community transit programs, funders—mainly, Federal Transportation Administration (FTA) and state and local governments—dictate indicators of performance. The non-urbanized (rural) area formula, known as FTA’s Section 5311 program, is administered through state Departments of Transportation (DOTs) and provides capital and operational funds to support transit programs for

residents living within census-defined populations of less than 50,000, providing rural residents with vital links to essential places of social and economic importance (KPH and Associates 2009; FTA 2010).

SAFETEA-LU (Safe, Accountable, Flexible and Efficient Transportation Equity Act—A Legacy for Users), which significantly increased both capital and operational funding for 5311 programs by nearly 74%, mandated the non-urbanized programs to report performance data through the National Transit Database (NTD) in 2005 (KPH & Associates 2009). However, long before this mandate, some DOTs required rural transit sub-recipients to submit quarterly performance data as part of their competitive allocation process following the increased transit funding under the Transportation Equity Act for Twenty-First Century (TEA-21) of 1998. DOTs performance data reporting may have provided the foundation for FTA's renewed requirements under subsequent transit policies (Sen et al. 2012).

Several provisions accompanied SAFETEA-LU's increased funding that provided the framework for transit providers to improve overall performance. For example, the policy afforded the flexibility to use non-DOT federal funds as a local match for FTA programs, to transfer operation equipment among providers, and to purchase and coordinate services. Implementation of such strategies renewed the focus on improving the overall rural transit performance, evidenced by increasing the mobility of transit-dependent individuals as well as efficiency and effectiveness (Burkhardt et al. 2004; Edrington and Brooks 2013; TTI 2012).

Although many studies have concentrated on identifying indicators for assessing the performance of larger urban transit programs, there has been limited focus on finding indicators that are consistent with non-urbanized transit environment. It has been decades since Carter and Lomax (1992) attempted to develop a methodology to evaluate the relative performance of operations of rural transit service funded through the Section 18 Program, finding limitations in comparability among agencies in rural areas that receive similar funding. Since then, some studies have proposed the need for alternative performance indicators for rural systems (see Radow and Winters 1998; Kosky 1999; Sen et al. 2012; Edrington and Brooks 2013). However, there is limited (if any) consistency among propositions, most of which are livability indicators, and many of the indicators are yet to be tested in non-urbanized settings.

In response to the call for diversified performance indicators data across transportation settings (Yusuf and Leavitt 2014), this study attempts to bring to light some of the unique indicators that some DOTs use, with focus on the Mississippi Department of Transportation's (MDOT) Section 5311 program. Non-urbanized transit systems use performance indicators that correspond to their operational goals, which are formulated based on the requirements of funding policies. For example, the goal of FTA Section 5311 funds aims at providing safe and accessible transportation to rural residents connecting to market centers, jobs, hospitals, education, and other essential areas of socio-economic importance (FTA n.d.). Rural transit agencies receiving FTA funding through MDOT set operational goals aimed at increasing ridership related to employment, medical, education, shopping, and others (mobility). In addition, the



agencies strive to adopt effective strategies to reduce cost (efficiency) and increase trips per service hour and miles covered (effectiveness).

As part of funding requirements, Section 5311 sub-recipients are mostly non-profit agencies and dependent largely on public funds (FTA n.d.). Consequently, all 16 providers included in this study depend on FTA funds administered through MDOT and state and local match funds. Funding consists of a federal/state and local share of 80%/20% of all project administrative, planning, and capital expenditures, with operating expenditures not exceeding 50%/50% of net operating costs (FTA 2010). Thus, it seems apparent that the accomplishment of operational goals is contingent upon the availability of funds. SAFETEA-LU increased rural transit funding by 74%, and the transit agencies could access funds through MDOT along with local funds from state and local governments by justifying the ability to achieve the goals identified above.

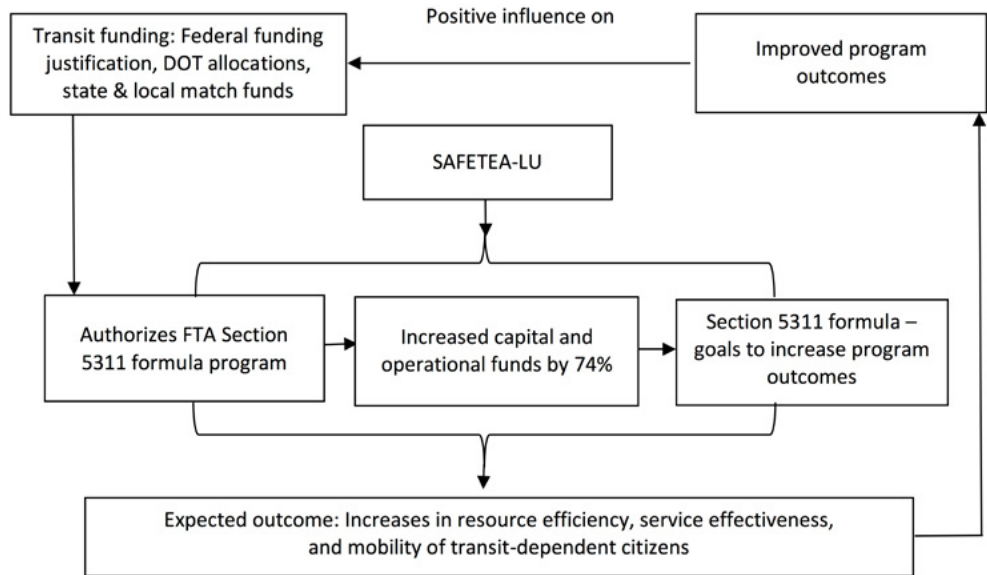
This study, therefore, used a synthesis of traditional and non-traditional performance indicators consistent with rural transit goals to verify if the transit agencies collectively met their mobility, efficiency, and effectiveness goals during SAFETEA-LU policy implementation in Mississippi. SAFETEA-LU expired in 2009, and subsequent funding authorized through continuing resolution expired in September 2012. However, the author used SAFETEA-LU policy implementation periods as a reference point for time-series data analysis to show how FTA Section 5311 programs in Mississippi use mobility data for measuring program outcomes. The study attempted to answer the following questions:

1. Did the selected rural transit agencies meet their goal of increasing the effectiveness of Section 5311 programs during SAFETEA-LU policy implementation?
2. To what extent did Section 5311 transit providers in Mississippi meet their efficiency goals during SAFETEA-LU policy implementation?
3. Did the Section 5311 program meet its mobility goals during SAFETEA-LU implementation in Mississippi?

### Conceptual Framework

The research questions were examined within the conceptual framework summarized in Figure 1. The public rational choice theory extension (Neiman and Stambough 1998) guided this framework. This theory assumes that for any funding policy reauthorization, policy-makers considered the benefits of increasing funds in relation to investment in such programs and, therefore, an increase in funding theoretically should result in increased transit program outcomes.

**FIGURE 1.**  
Conceptual framework for evaluating MDOT's Section 5311 program outcomes during SAFETEA-LU implementation



Consequently, the framework was based on the proposition that an increase in transit funding under SAFETEA-LU (capital and operational funds for the Section 5311 programs) along with other policy strategies should assist rural transit providers in reaching their performance goals. Because non-urbanized transit goals are tied mostly to funding objectives and requirements, MDOT's ability to monitor and report performance outcomes could inform funding decisions at the state and local levels. Rural transit agencies, therefore, report program outcomes to inform policy- and decision-makers about transit benefits and effects on communities. Improved outcomes may positively influence transit funding and allocation decisions at the federal, state, and local levels (Figure 1). This study does not intend to make any causal assertions regarding the impact of SAFETEA-LU policy on transit performance outcomes. Rather, it extends the theoretical and practical propositions concerning the use of different performance indicators to evaluate and communicate rural program outcomes, given the funding goals and requirements within the unique rural transit environment.

### Related Literature: Performance Measurement and Evaluation in the Transit Industry

Performance measurement is used not only to identify and remedy problems among employees or to justify budgets and expenditures, but also to measure improvements in performance and document the program impact on the communities (Fielding 1987; FTA 2010). Without proper performance data, transit managers have no yardstick to improve existing services, plan for future services, or justify the continuation of existing services. Performance evaluation also helps to assess the returns on investment to justify government intervention resulting from market failures.

When local governments took over problematic transit operations and federal government subsidies became available, ridership and revenue—used to gauge urban transit performance—no longer were considered adequate measures of performance

(Winston 2000; Karlaftis 2004). In many cases, evaluation of government-funded programs examines the benefits society may derive or improvement in the quality of life of target populations. Consequently, research and experts suggest that since the outcome of program evaluation may negatively affect the survival of most public programs, it is important to select indicators that are unique to each program rather than use general performance indicators (see Behn 2003; Hatry et al. 2010; Wholey 2010).

Because of the lack of a market-oriented guide to performance measurements, it was hypothesized that a more balanced assessment would help capture the new multi-dimensional nature of transit operational performance (Carter and Lomax 1992; Karlaftis 2004; Espino et al. 2007). Efficiency and effectiveness constructs became the traditional measures, and researchers have used these indicators widely to examine improvement in urban transit performance and productivity (e.g., Berechman 1993; Karlaftis and McCarthy 2002; Karlaftis 2004). Indicators used with these constructs include revenue passengers per service area population, total passengers per vehicle hour or mile, and revenue per vehicle hour or mile (effectiveness variables) as well as cost per vehicle mile or hour and cost per trip (efficiency variables) (Fielding 1987). However, research has emphasized that efficiency and effectiveness indicators work very well in the urban transit environment and are considered less effective when used alone for evaluating non-urbanized transit performance (Burkhardt et al. 2004; Ellis and KFH Group Inc. 2009).

Based on earlier research, some empirical studies have explored ways of incorporating the unique rural transit environment into the traditional efficiency/effectiveness measurement of performance analysis. Bitzan and Hough (1994) developed a guidebook for evaluating performance in rural and small urban transit systems for the Mountain Plains Region, in which they divided performance measures into efficiency and effectiveness categories. Efficiency categories were cost of operations, labor, administration, revenue, maintenance, and vehicles. Effectiveness categories were social and service utilization. Each category contained general measures that can be used to evaluate the overall system performance (Hough et al. 1997).

By 1998, a few state DOTs had developed performance measures specifically to allocate state transit funds to rural transit programs through a competitive process. For example, MDOT developed performance measurement indicators for assessing productivity, efficiency, and effectiveness similar to the Mountain Plains Region's performance categories (MDOT 1998). In addition, MDOT uses service characteristics (called mobility indicators) as part of its performance indicators.

Other empirical studies on non-urbanized and demand-response transit performance have used efficiency and effectiveness ratios to assess performance and productivity (e.g., Burkhardt et al. 2004; Ellis and KFH Group Inc. 2009). The results of these studies showed that many of these indicators could not adequately inform policy- and decision-makers on goals achievement. Also, there have been questions regarding the comparability of findings across studies, as they yielded conflicting results (Karlaftis 2004). These concerns led to the conclusion that no single indicator or method could

reveal the relative outcome of transit operations, but a combination of reliable and consistent mix of indicators could (Behn 2003; Hatry et al. 2010; Wholey 2010).

Moreover, studies have found that non-urbanized transit operates in unique environments, such as distinctively large geographic areas with low population densities, lower-income groups, more demand-response services, and distinct categories of transit-dependent groups (Economic Research Service 2005; Radow and Winters 1998). In addition, travel is for longer distances, using resources that often are strained and stretched (Ellis and KFH Group Inc. 2009). Consequently, rural transit programs require varied forms of performance indicators that are consistent with their goals and provide insight into transit benefits to communities (Radow and Winters 1998; Kosky 1999; Burkhardt et al. 2004; Edrington and Brooks 2013). Although some contend that varied forms of indicators could be used to remove any skewed outcomes that may result from the exclusive use of traditional efficiency and effectiveness performance analysis (Radow and Winters 1998), others indicate that different purposes require different measures (Behn 2003).

Other performance categories found in rural transit literature include accessibility, mobility, safety, system preservation, and reliability measures (see Burkhardt et al. 2004; Caltrans 2006). The definitions of mobility measures differ across states. For example, Caltrans identified level of service (LOS) as the primary measure of mobility whereby several counties reported ridership trends without any particular mobility data. However, Caltrans' report proposed automating count data to record critical locations or destinations (Caltrans 2006). In the case of Mississippi and Arkansas, mobility data include the type of destination and trip purpose data, which reveal the impact of the transit services on a community in increasing mobility. These data types are consistent with quality-of-life measures such as the number of passengers transported to meal sites, social and recreational centers, employment, and other socially- and economically-beneficial destinations (Radow and Winters 1998; Kosky 1999).

Researchers from Texas A&M Transportation Institute recommend the use of alternative indicators in analyzing rural transit and coordinated transit performance (Sen et al. 2012). These indicators help document how the transit system affects business, employment, health care, or other issues important to the community; more importantly, the measures address what would happen if the transit system did not exist (Edrington and Brooks 2013). Such measures also show how the mobility needs of communities are being met through rural transit systems using specific types of service data as indicators of performance outcomes (Sen et al. 2012).

Even though the transit performance literature shows no uniform set of measures for assessing performance, it revealed three macro constructs that have been used in specific settings to evaluate rural transit program outcomes: service effectiveness, resource efficiency, and mobility measures. Service effectiveness, as identified in the literature, assesses the amount of public transportation service consumed (revenue received or passenger trips) per the quantity of service provided. Thus, the more service consumption (or passenger revenue or passenger trips) per service output (vehicle miles and hours), the higher the level of service effectiveness (Burkhardt et al. 2004).

Resource efficiency, on the other hand, measures the amount of resources expended (operating cost) per unit of rural transit service (vehicle hours or miles and total passenger trips) (Fielding et al. 1985; Karlaftis and McCarthy 2002; Burkhardt et al. 2004). Thus, the smaller the amount of resources expended to produce a unit of service, the greater the resource efficiency of the public transportation service (Burkhardt et al. 2004). These measures are necessary because transit agencies transport clients within the constraints of existing resources, and resource increases, such as SAFETEA-LU funding, should have an effect on program outcomes.

The mobility indicators include those that relate to trip, services, and passenger types (Radow and Winters 1998; Kosky 1999). These trip characteristics indicate how the mobility needs of various categories of rural residents were being met before and after funding increased under SAFETEA-LU implementation. Trip characteristics include employment, medical, education, health and human services (HHS), shopping, and recreational destinations (Radow and Winters 1998).

## Methodology

### Variables Included in This Study

All the three constructs discussed (effectiveness, efficiency, and mobility) consist of many variables for measuring performance outcomes. However, the author selected only those variables that MDOT commonly uses to compare how each construct could better inform funding decision-makers about rural transit program outcomes. Table 1 summarizes the macro constructs and variables within the scope of this case study.

**TABLE 1.**  
Selected Performance  
Construct for MDOT's  
Non-Urbanized Transit  
Performance

Macro Constructs/ Indicators	Component of Macro Construct Being Measured	Variable/Measure
Service Effectiveness	Service utilization	Passenger trips per hour, and total revenue per mile
Resource Efficiency	Resource utilization	Operating cost per passenger trips and cost per vehicle mile
Mobility	Mobility of transit-dependent – using transit to meet mobility needs, trip/service types	Number of employment-related, medical, HHS, education/training, and shopping trips

Total operating cost is the cost of operating a transit system, including all labor, materials, and services necessary for operations, maintenance, and administration but excluding capital cost (per NTD). Revenue (contract and fare) hours and miles are the hours and miles that vehicles are in passenger service or available (with a driver) for service (per NTD). Passenger or service trips variable, including trip types, as used in this study, is a count of the number of passengers who board the Section 5311-funded vehicle, with passengers counted each time they board a vehicle.

Mobility indicators include the following:

1. *Employment-related trips* are trips to and from places of employment, including all trips related to Temporary Assistance for Needy Families (TANF) clients.
2. *Medical trips* are trips to doctor offices, clinics, and hospitals and all trips for receiving medical services, including Medicaid-sponsored trips.
3. *HHS trips* are human service agency trips often provided under contract with human service agencies and include trips related to social service functions such as housing, shelter, clothing, Food Stamps, and Medicare assistance.
4. *Education/training trips* are trips to schools, colleges, and other facilities for the purposes of receiving education and training. These include trips to Head Start programs.
5. *Shopping/personal trips* are trips to stores, beauty salons, utility companies, post offices, County courthouses, City halls, and other personal trips.

### **The Case of Mississippi's Rural Transit**

A preliminary exploration of other states' rural transit data identified Mississippi as the only state that provides all conditions necessary for testing the propositions set by the study. MDOT is one of the few state DOTs that continually had collected diversified 5311 performance data before NTD reporting became a mandate under SAFETEA-LU. Hence, the unique type of data collected by MDOT and the use of the data in the competitive allocation process represents a peculiar case for the testing usefulness of diverse performance data in a rural transit environment.

Unlike many state DOTs that allocate funds by some prescribed formulas, MDOT uses a competitive selection process. MDOT and the Interagency Transportation Committee (ITC) select the projects to ensure a feasible resource coordination, utilization, and efficiency across the state (MDOT State Management Plan [SMP] 2011). The process gives priority to existing Section 5311 providers that demonstrate effective coordination of available resources and otherwise have been operating satisfactorily based on the MDOT's monitoring, review, and audit procedures. Providers must have measurable service delivery goals and specific objectives to meet service demands as part of grant allocation rankings (MDOT SMP 2011). Thus, sub-recipients must document changes in specific services provided (mobility variables), efficiency and effectiveness goals, and a possible expansion of service area and marketing efforts over a two-year period (MDOT SMP 2011).

To provide a balanced approach to rural transit performance measurement (Carter and Lomax 1992; Radow and Winters 1999), MDOT combines the traditional efficiency and effectiveness indicators with non-traditional indicators called mobility indicators (which reflect FTA Section 5311 funding policy goals) for monitoring program outcomes. MDOT's Transit Division has received first-hand mandatory quarterly data from sub-recipients and maintained detailed operational data since 1999, and MDOT and ITC have used performance data and other service operational criteria to select projects in the competitive grant circles since 2000. In addition, MDOT reports the data to NTD



under SAFETEA-LU requirements and publishes performance outcomes in an Annual Statewide Coordination Summit book for public consumption. The annual reporting is part of a continuous attempt to educate transportation stakeholders and funding decision-makers at all levels of government about the benefits of transit programs.

### **Study Design and Data**

This study employed a single evaluative case study design with embedded units of analysis (Yin 2009). Mississippi's Section 5311 program was the case, and the units of analysis constituted 16 rural transit providers receiving Section 5311 grant through MDOT. Using a before-and-after design (Berman 2007; Yin 2009), the study assessed how the Section 5311 program in Mississippi met its program goals during SAFETEA-LU implementation. Data for this study were obtained from MDOT's Automated Transit Data System (ATDS).

Overall, 16 out of 22 (73%) Section 5311 providers that were in good standing regarding goal setting, FTA funding receipts, and quarterly data reporting were included in the study. The 16 providers satisfied the conditions for pairing the data for conducting a paired sample t-test and time-series analysis. The data collected cover 8 years or 32 quarters (September 2001–October 2009) of Federal Fiscal (FF) years, representing four years before and four years after SAFETEA-LU implementation. In total, 512 datasets were uploaded to SPSS software, which generated 32 sets of time-series data for the statistical analysis. Each quarterly data point represents a quarterly average of data reported.

### **Methods of Analysis**

SPSS was used to run the paired sample t-test to compare the means of dependent variables (which are related variables) during the pre-policy and policy periods. This type of test assumes that both variables are at interval or ratio levels and were measured with the same scale. In addition, time-series regression with linear trend analysis—the best fit for evaluating outcomes over a period and for the forecasting effect of increased federal funding (Berman 2007)—were used to compare quarterly trends of performance indicators over the pre-policy and policy periods. A trend line equation that linked two variables provided an added explanation of any slight changes observed from one period to the other, thus predicting how one variable will change given any change in other future resources (Berman 2007). The pre-policy and policy periods were the independent variables. Thus, the independent variables were continuous or dichotomous (dummy variables). The dependent variables were continuous, comprising the quarterly operational data (passenger trips per hour, revenue per mile, cost per mile, cost per hour, and trip/service types related to education, employment, HHS, medical, and shopping).

The pre-SAFETEA-LU period covered the data-reporting period of October 2001 through September 2005, and the implementation period covered October 2005 through September 2009. The trend line equations (regression coefficients) were analyzed separately for the two periods without creating any interruptions. The coefficients in each pair were tested and were statistically different from each other. The omitted variables from each period did not make any difference in the overall results.

Trend lines allowed the researcher to identify changes over the pre-policy and policy periods.

Error terms in time series regression met the same assumptions concerning normality—the absence of outliers, linearity heteroscedasticity, and multicollinearity. Any identified effects of outliers on regression conclusions were examined by re-estimating averages and then examining conclusions for substantive robustness. Even though caution was taken in comparing performance indicators, there were some variations in passenger data. Unequal variances of the error terms were detected graphically by examination of error term plots for unequal variance, transforming the affected variables, and adjusting the scale to reduce the differences between variables (Stevens 2002; Berman 2007). The independent variables were linearly related to dependent variables and did not exhibit the problem of multicollinearity (Berman 2007).

Autocorrelation reflects correlation in the order in which observations are measured. Durban-Watson test statistics (DWTS) were used to prevent the problem with autocorrelation. The values of DWTS ranged from 0–4. Values close to 2 indicated a lack of serial correlation, and values close to 0 and 4 indicated serial correlation. Values less than 2 indicated positive serial correlation; values greater than 2 indicated a negative. The DWTS of variables analyzed exhibited the limited presence of autocorrelation. However, the trend variables added to the model helped to control any problem that may exist.

## Results

### Effectiveness Construct

Operational effectiveness did not show any improvement during SAFETEA-LU implementation. The indicators (passenger trips per hour and revenue per mile) decreased during the policy period. The results are summarized in Table 2. The average passenger trips per hour during the policy implementation period were slightly lower ( $m=3.36$ ,  $SE=0.173$ ) than the mean during the pre-policy period ( $m=4.30$ ,  $SE=0.126$ )—thus, a 22% decrease in passenger trips per hour during the policy implementation period (see Table 2). The t-test found a significant decrease in passenger trips per hour after SAFETEA-LU implementation ( $t(30)=4.408$ ,  $p<0.01$ ). The trend analysis also showed a rapid quarterly decline in the variable during pre-policy and policy implementation periods (see Figure 2).

**TABLE 2.**  
Means Test of  
Effectiveness Indicators

Indicators		Means	SE	% Change	t	Sig. (2-tailed)
Passenger trips per hour	Pre-policy	4.3004	0.12653	-22	4.408**	0.000
	Policy period	3.3551	0.17312			
Revenue per mile	Pre-policy	0.7919	0.03844	-50	8.512**	0.000
	Policy period	0.3985	0.02566			

N= 32      \* $p<0.05$       \*\* $p<0.01$



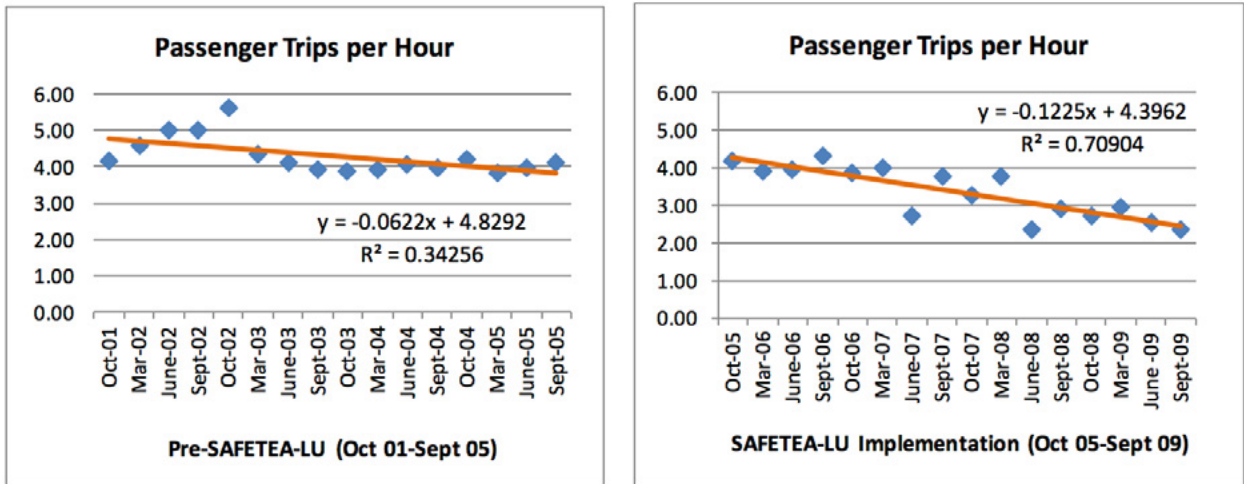


FIGURE 2. Passenger trips per hour trend comparison (quarterly averages), FFY 2001–2009

The revenue per mile recorded during the policy implementation period was much lower ( $m=0.3935$ ,  $SE=0.025$ ) than that of the same variable during the pre-policy period ( $m=0.7919$ ,  $SE=0.038$ ). This represents a 50% decrease in revenue per mile during the policy implementation period (see Table 2). The t-test (Table 2) confirmed that there was a significant difference ( $t(30)=8.512$ ,  $p<0.01$ ). The trend analysis in Figure 3 revealed that the rate of quarterly decline continued during the implementation of SAFETEA-LU period, but at a slower pace.

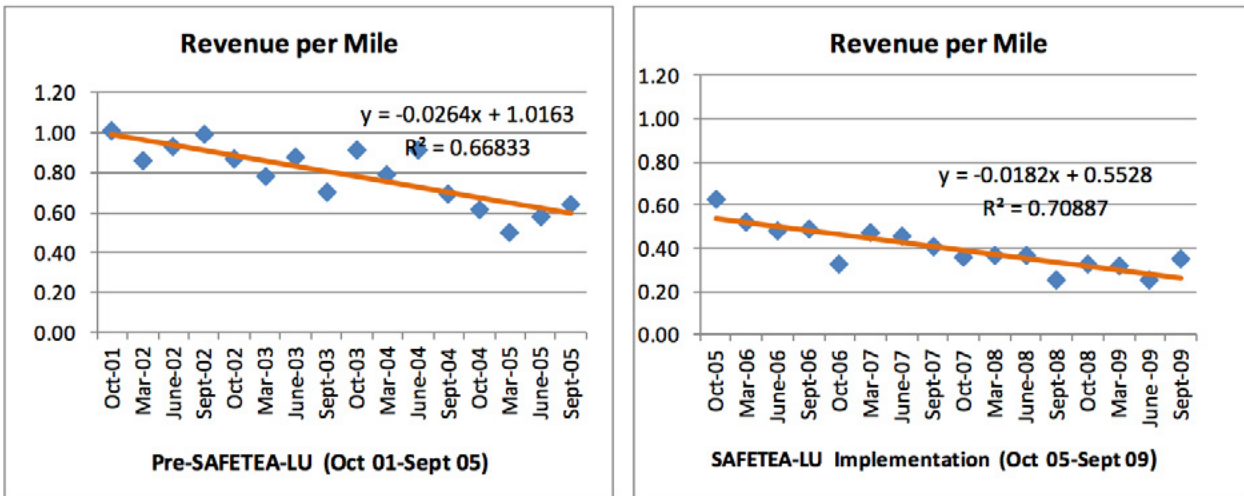


FIGURE 3. Revenue per mile trend comparison (quarterly averages), FFY 2001–2009

**Efficiency Construct**

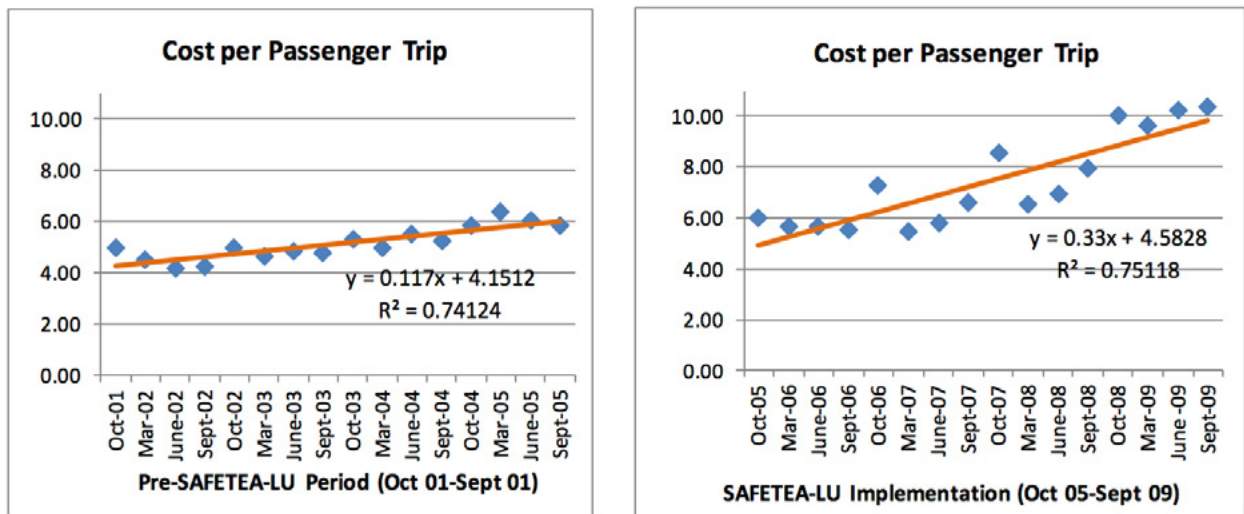
Resource efficiency indicators did not show any improvement during SAFETEA-LU implementation. Table 3 provides a summary of statistics for both variables. Cost per passenger trip during the policy period was 44% higher (m=7.3789, SE=0.453) than that of the pre-policy period (m=5.146, SE=0.162), whereas that of cost per mile increased by 9%.

**TABLE 3.**  
Means Test of  
Efficiency Indicators

Indicators		Means	SE	% Change	t	Sig. (2-tailed)
Cost per passenger trip	Pre-policy	5.146	0.162	44%	-4.659**	0.000
	Policy period	7.389	0.453			
Cost per mile	Pre-policy	0.869	0.024	9%	-1.947	0.061
	Policy period	0.945	0.031			

N=32 \*p<0.05 \*\*p<0.01

The t-test for cost per passenger trip showed a significant difference (t(30)=-4.659, p<0.01). However, the t-test for cost per mile found no significant difference (t(30)=-1.947, p>0.05) during the policy implementation period (see Table 3). The quarterly trends in cost per output in both variables (cost per passenger trip and cost per mile) increased dramatically during SAFETEA-LU implementation (see Figure 4).



**FIGURE 4.** Cost per passenger trip trend comparison (quarterly averages), FFY 2001–2009

**Mobility Constructs**

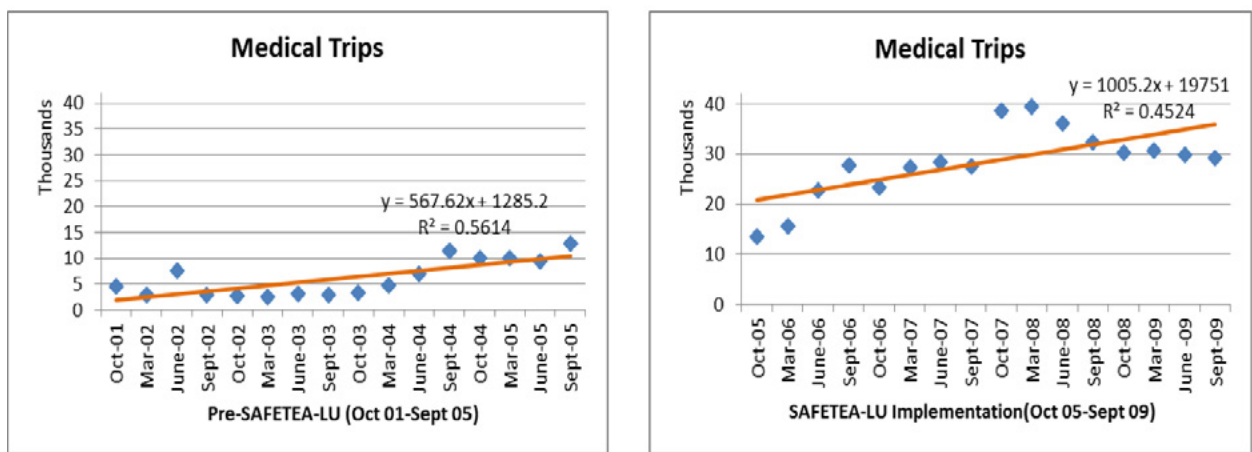
The analysis revealed an increase in medical, HHS, and education/training trips during policy implementation. However, employment- and shopping-related trips decreased during the policy implementation period. Table 4 summarizes the statistical analysis. During policy implementation, medical trips for all 16 transit agencies were 363% higher (m=28295, SE=1779) than the mean recorded during the pre-policy period (m=6110, SE=902). The t-test also found a significant difference (t(30)=-11.124, p<0.01)

(see Table 4). The trend analysis revealed significant quarterly increases in medical trips during the pre-policy period, which almost doubled during the policy implementation period (see Figure 5). Similarly, HHS trips recorded during the policy implementation period were higher ( $m=22647$ ,  $SE=1125$ ) than those of the pre-policy period ( $m=11504$ ,  $SE=697$ ). This presents a 97% increase (11143 more HHS trips) during the SAFETEA-LU implementation period. The t-test also found a significant difference ( $t(30)=-8.418$ ,  $p<0.01$ ) in HHS service trips (see Table 4). The quarterly trends also showed continued increases during the pre-policy and policy implementation periods.

**TABLE 4.**  
Means Test of Mobility Indicators (Trip/Service Characteristics)

Indicators	Policy Periods	Mean	Std. Error Mean (SE)	% Change	t	Sig. 2-tailed
Medical	Pre-policy	6110.000	901.661	363%	-11.124**	.000
	Policy Period	28295.375	1778.848			
HHS	Pre-policy	11504.375	697.495	97%	-8.418**	.000
	Policy Period	22647.375	1125.084			
Education & training	Pre-policy	13349.813	347.546	25%	-6.601**	.000
	Policy Period	16752.563	380.764			
Employment	Pre-policy	59351.938	3220.887	-41%	6.953**	.000
	Policy Period	35052.813	1356.222			
Shopping/ personal/Other	Pre-policy	34658.063	1189.914	-19%	4.146**	.000
	Policy Period	28220.563	997.397			
Total passenger/ service trips	Pre-policy	186949.81	2698.348	-3%	1.142	.262
	Policy period	182177.81	3188.820			

N=32 \* $p < 0.05$  \*\* $p < 0.01$



**FIGURE 5.** 5311 Medical-related trips trends comparison (quarterly averages), FFY 2001–2009

Education/training trips increased by 25% ( $m=16753$ ,  $SE=381$ ) during the policy implementation period compared to the pre-policy period ( $m=13349$ ,  $SE=347$ ) (see Table 4). The t-test also found a significant difference ( $t(30)=-6.601$ ,  $p<0.01$ ) in education/training trips during SAFETEA-LU implementation. However, there was a quarterly rate of decline observed in the trend analysis.

On the other hand, the average number of employment-related trips showed a 41% decline during SAFETEA-LU implementation period, as shown in Table 4. The t-test found a statistically-significant difference ( $t(30)=-6.953$ ,  $p<0.01$ ). However, the trend analysis showed that transit providers were losing 2141 employment-related trips quarterly during the pre-SAFETEA-LU period. This decreasing trend seemed to have improved, with a quarterly loss of only 835 trips during SAFETEA-LU implementation period (see Figure 6).

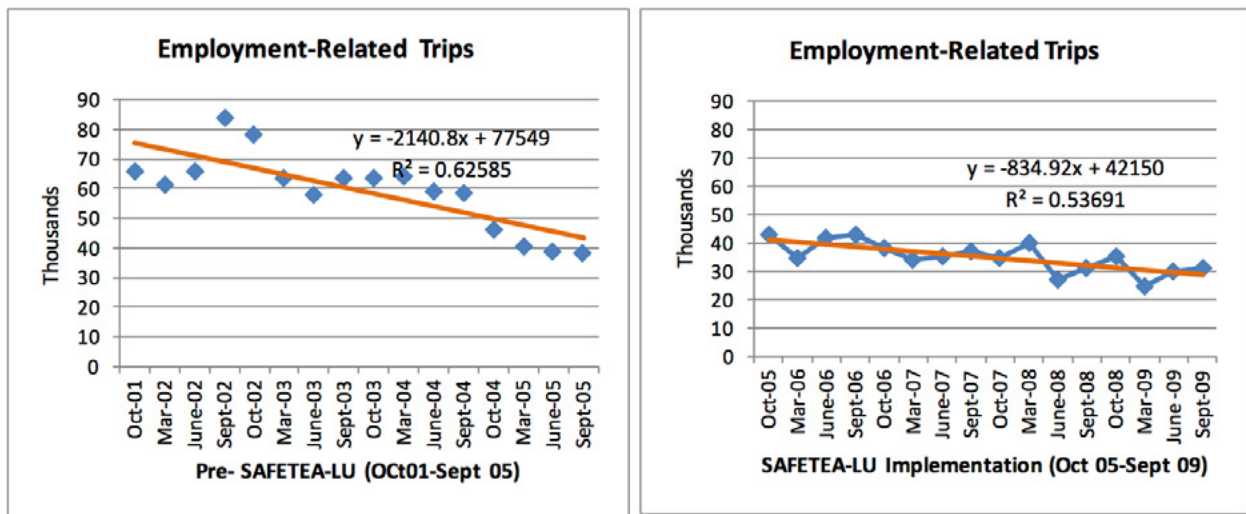


FIGURE 6. 5311 Employment related trips trends comparison (quarterly averages), FFY 2001–2009

Shopping-related trips followed a similar trend as employment trips, with a reduction in the average shopping trips during policy implementation period—thus, 19% lower ( $m=28221$ ,  $SE=997$ ) than that of the pre-policy period ( $m=34658$ ,  $SE=1189$ ) (see Table 4). The trend analysis also showed a quarterly loss of 441 shopping trips during the pre-SAFETEA-LU period. This trend, however, slowed down to only 193 quarterly losses during the policy implementation period.

A means test for total passenger trips was calculated to verify the changes in total service trips for 5311 programs during SAFETEA-LU implementation. Total trips during the policy implementation period were slightly lower ( $m=182177.81$ ,  $SE=3188.820$ ) than those of the pre-policy period ( $m=186949.81$ ,  $SE=2698.348$ ), representing a 3% decrease in average total passenger trips during the policy implementation period (see Table 4). The t-test, however, found no significant difference ( $t(30)=1.142$ ,  $p>0.05$ ), as trends in the quarterly loss of total passenger trips also slowed down significantly.

In summary, effectiveness in terms of passengers per hour and revenue per miles decreased during the policy implementation period, with a slight improvement in quarterly trends in revenue per mile. The efficiency indicators showed a high cost per trip and mile. On the other hand, mobility indicators revealed a significant increase in medical, HHS, education, and training trips. Although total shopping and employment-related trips decreased, there was an observed gradual improvement in quarterly losses.

## Discussion of Results

This study focused on exploring diversified indicators for evaluating non-urbanized transit (Section 5311) program outcomes in Mississippi. It followed the proposition that rural transit goals are linked to government funding. Therefore, the increased funding made available under the SAFETEA-LU policy should assist providers in meeting most of their goals of increasing program outcomes. The main outcomes expected of MDOT-supervised rural transit providers include increasing effectiveness, efficiency, and mobility. The before-and-after design was used to examine how the transit agencies included in this study met their goals during SAFETEA-LU implementation in Mississippi. The dynamics of the various indicators provided an explanation of how the agencies achieved their goals during the study period. A mix of traditional service effectiveness and resource efficiency indicators and non-traditional mobility indicators were tested.

The results of the paired t-test and the trend analysis showed no significant indication that rural transit agencies met their efficiency and effectiveness goals. In analyzing effectiveness, it was expected that the more service consumption (passenger trips or revenue) per service output (miles or hours), the higher the level of service effectiveness (Burkhardt et al 2004; Ellis and KFH 2009). The results revealed a reduction in trips per hour and revenue per miles during the policy period. However, the rate of quarterly decline in revenue per mile appears to be slowing down. If this trend continues, then it could be predicted that a continuous increase in funding may eventually improve revenue per mile. In the case of resource efficiency analysis, the expected outcome was an improvement in resource efficiency, as evidenced by a reduction in cost per trip and cost per mile (Burkhardt et al. 2004) during the implementation of SAFETEA-LU. This measure is an important variable for analyzing goal achievement because transit agencies transport clients within the constraints of existing resources and, therefore, resource increases should have an impact on performance service outcomes (Radow and Winters 1999). However, the results of the analysis proved otherwise, showing a high cost per trip and mile during SAFETEA-LU implementation. This trend may be due to the increased funds made available under SAFETEA-LU policy. The increased cost proportions may have translated only to improvement in some mobility indicators. The results of the efficiency and effectiveness indicators were consistent with other studies on transit performance hypothesis, which indicates that these traditional indicators may show no improvement in rural transit performance (Burkhardt et al. 2004) due to the unique rural transit environment (Radow and Winters 1999).

On the other hand, the analysis of mobility indicators revealed that the selected transit providers in Mississippi met some of their mobility goals during SAFETEA-LU



implementation. The types of services provided to clients represented how the mobility needs of some rural transit-dependent persons improved during the SAFETEA-LU policy implementation period. There was a significant increase in medical and HHS trips and a slight improvement in education- and training-related trips. Even though there was a decrease in employment- and shopping-related trips, the trend analysis revealed that the declining quarterly trends observed before SAFETEA-LU implementation was improving gradually.

The decrease in employment- and shopping-related trips was significant from 2007–2009, which may be explained by three conditions. First, it could be attributed to the introduction of Job Access and Reverse Commute (JARC) services in some areas, which were not included in this study. Second, other providers that started services after SAFETEA-LU implementation were not included in this study. Third, since employment trips were their lowest between 2007 and 2009, it could be attributed to job losses during the economic recession. The recession reached its highest peak in 2008 (*Wall Street Journal* 2008) and may have affected shopping trips with the reduction in purchasing power. If the trend observed in the analysis continues, then employment and shopping trips are likely to improve as conditions improve and resources increase with time.

### **Implications for Policy and Practice**

This study has shed light on how the three diverse performance constructs behave in non-urbanized transit performance evaluation. Although all the indicators matched specific goals typically set by transit providers, only mobility indicators exhibited some positive goal achievement during the implementation of SAFETEA-LU in Mississippi. Consequently, if only the traditional efficiency and effectiveness variables were used in Mississippi's Section 5311 allocation decisions, the ITC, for instance, would not select any of the transit providers included in this study mainly because none of the traditional variables showed any positive improvement. This study, therefore, informs funding decisions and performance reporting policies and practices in many ways.

First, the improvement observed in some mobility outcomes in this study may imply that more services were available to users accessing medical, HHS, and education/ training services during SAFETEA-LU implementation. This outcome could mean enhancement in the quality of life of transit-dependent persons (Kosky 1999; Edrington and Brooks 2013). In Mississippi, such outcomes inspire funding decisions at the state and local levels (MDOT Summit Report 2013). Thus, adding mobility measures to the traditional performance indicators provides the balance needed for rural performance outcomes (Carter and Lomax 1992; Espino et al. 2007) and allows policy-making and funding decision-makers to appreciate rural transit programs and their impact on persons who depend on them.

Second, since mobility indicators define specific services provided, including such indicators in diversified performance measures could be an effective benchmarking and marketing tool for transit providers to get service contracts within municipalities. Consistent with Radow and Winters (1998), identifying specific indicators allows MDOT

rural transit providers to tell their story and market their programs to specific targets such as hospitals, education institutions, and employment agencies. These targeted measures allow for comparison and consistency of monitoring trends among providers and provide a common measure for examining the socio-economic impact of transit services and returns on public investments. Not only could such data be harmonized, it also could be humanized through practical results sharing.

Third, the results of such analysis may influence funding directions in non-urbanized settings. The gradual improvements in performance trends, as observed in some of the variables, may imply that program requires time to improve after funds have become available. Thus, there is a possibility of increasing program outcomes if policy-makers approve continuous funding of rural transit programs.

Furthermore, since the introduction of formula programs, rural transit agencies in states such as Mississippi have had to convince state and local authorities about transit program benefits to obtain match funds (RTAP and CTAA 2008; Radow and Winters 1999). Thus, transit agencies should use those indicators that can best inform local and state funding authorities and stakeholders. By adding mobility indicators identified in this case study to the traditional efficiency and effectiveness measures, Mississippi transit providers could communicate some positive program outcomes to funding decision-makers at the state and local levels.

Moreover, under the current federal transportation legislation (MAP-21, Moving Ahead in the 21st Century) and subsequent policies, there has been a continuous emphasis on performance measurement whereby transit funding will be based on performance outcomes. Such policy direction requires government-funded non-urbanized transit agencies to adopt effective performance measures. Since most rural transit program outcomes are dependent on government funding, it is essential that performance reporting measures be formulated to capture variables that are adaptable to all rural transit programs' needs (Radow and Winters 1998; Kosky 1999; Sen et al. 2012; Edrington and Brooks 2013). MDOT's type of mobility variables, as used in this case study, may provide this opportunity. Adding mobility indicators to the traditional NTD reporting could provide a better understanding of transit performance outcomes for national policy decision-making. Such indicators may feed directly into FTA goals for Section 5311 programs and enhance FTA performance reports to justify budgets, continuous funding, and policy decisions at the federal level.

## **Conclusion**

This case study adds to the contemporary discussion on using adaptable indicators such as MDOT's mobility indicators to supplement the traditional rural performance reporting. The results of the analysis revealed that some mobility indicators showed positive outcomes compared to the traditional efficiency and effectiveness indicators included in this study. Although there is nothing revolutionary about transit performance measures, the use of a mobility construct as identified in Mississippi's case study better communicates non-urbanized transit program outcomes. Consistent with rural transit literature, adding mobility indicators as part of overall performance



measurement may serve as useful benchmarks, particularly when evaluating funding policy impact at the state level (Loitine and Lawrence 1988). The use of mobility as part of diversified transit performance measures may enable transit stakeholders to appreciate the benefits of rural transit programs in their communities and stimulate support and investment in non-urbanized transit programs.

### **Limitations and Prospects for Future Research**

As with any social research, this paper has some limitations that also offer opportunities for future studies. First, because of the diverse nature of Mississippi's rural communities, many factors may influence operational performance; the socio-economic, political, geographic, and capital investments and other influences on transit data may vary considerably among providers and their data reporting. The study did not control for such factors because such data were not available. Therefore, the results will be generalizable to providers in localities that shares similar characteristics with the Mississippi's transit environment.

Second, to satisfy data pairing requirements of the paired sample t-test analysis, the study did not include providers that did not have matching data for both pre-policy and policy periods. Thus, the study used 8 years or 32 quarters or periods in a paired sample t-test and time series linear trend analysis. Even though the literature supports the use of such data points in a single evaluative case study (Yin 2009; Berman 2007), a small sample may limit the statistical power of the test. However, significant effects were found, suggesting enough power that justifies the test (Cohen 1992; Stevens 2002). Future research may capture all providers when assessing overall transit performance.

A prospective study also may examine the achievement of other FTA formula program goals to include MAP-21 or future policy time frames, if paired data are available, to increase the data points. Another study may extend this study by testing whether the improving trends observed in some variables actually improved the outcomes over time. Moreover, this case study offers the opportunity for research and practice in identifying and adopting non-traditional mobility indicators that are consistent across different levels of spatial relations (local, regional, state) for evaluating rural transit program outcomes.

### **Acknowledgments**

The author is extremely thankful to Charles Carr, Director of Intermodal Planning at MDOT and Dr. Johnny B. Gilleylen of Jackson State University for their professional input. Appreciation also is extended for the assistance provided by Shirley Wilson, Zenotha Robinson, and other staff of MDOT's Transit Division in the data collection process.

## References

- Behn, R. D. 2003. "Why Measure Performance? Different Purposes Require Different Measures." *Public Administration Review*, 63(5): 586-606.
- Berechman, J. 1993. *Public Transit Economics and Deregulation Policy*. BV, Amsterdam: Elsevier Science Publishers.
- Berman, E. M. 2007. *Essential Statistics for Public Managers and Policy Analysts*. 2nd ed. Washington, DC: CQ Press.
- Bitzan, J., and J. Hough. 1994. *An Evaluation Guidebook for Rural and Small Urban Transportation Systems in the Mountain-Plains Region*. Fargo, ND: Upper Great Plains Transportation, Institute North Dakota State University, J\1PC Report No. 94-36.
- Burkhardt, J. E., C. A. Nelson., G. Murray, and D. Koffman. 2004. *Toolkit for Rural Community Coordinated Transportation Services*. Transit Cooperative Research Program (TCRP) Report 101.
- Caltrans. 2006. *Performance Measures for Rural Transportation Systems: A Technical Supplement, a Guidebook*. California: Caltrans.
- Carter, D. N., and T. J. Lomax. 1992. "Development and Application of Performance Measures for Rural Public Transportation Operators." *Transportation Research Record*, 1338.
- Cohen, J. 1992. "The Power Primer." *Psychological Bulletin*, 112(1): 155-159
- Economic Research Service (ERS). 2005. "Rural Transportation at a Glance." Washington DC: U.S. Department of Agriculture (USDA), Agriculture Information Bulletin, 795.
- Edrington, S., and J. P. Brooks. 2013. "Connection between Rural Transit and Rural Livability." Paper presented at 92nd TRB Annual Meeting, January 12-16.
- Ellis, E., and KFH Group Inc. 2009 *Guidebook for Rural Demand-Response Transportation: Measuring, Assessing, and Improving Performance*, TCRP Report 136.
- Espino, R, J. de Dios Ortúzar, and C. Román. 2007 "Understanding Suburban Travel Demand: Flexible Modeling with Revealed and Stated Choice Data." *Transportation Research Part A: Policy and Practice*, 41(10): 899-912.
- Fielding, G. J. 1987. *Managing Transit Strategically*. San Fransisco, CA: Jossey-Bass Publishers.
- Fielding, G. J., T. T. Babitsky, and M. E. Brenner. 1985. "Performance Evaluation for Bus Transit." *Transportation Research Part A: General*, 19(1): 73-82.
- Federal Transit Administration (FTA) 2010. "Performance Based Management Agenda, Issued as Part of Overall Federal Highway Administration's National Performance Agenda.: *Compendium of Papers*, Transportation Research Board, January 2010.
- FTA, n.d. "Formula Grants for Other than Urbanized Areas (5311)." [http://www.fta.dot.gov/grants/13093\\_3555.html](http://www.fta.dot.gov/grants/13093_3555.html). Accessed June 2014.

- Hatry, H. P., J. S. Wholey, and K. E. Newcomer. 2010 "Evaluation Challenges, Issues, and Trends." In *Handbook of Practical Program Evaluation*, Wholey J. S., H. P. Harry, and K. E. Newcomer (eds). San Francisco: Jossey Bass.
- Hough, J., A., D. Tolliver, and J. Bitzan, 1997. "Performance of Coordinated and Non-Coordinated Rural Transit Systems in the Mountain-Plains Region." Fargo, ND: Mountain-Plains Consortium, Series MPC Report.
- Karlaftis, M. G., and P. McCarthy. 2002 "Cost Structures of Public Transit Systems: A Panel Data Analysis." *Transportation Research Part E: Logistics and Transportation Review* 38(1): 1-18.
- Karlaftis, M. G. 2004 "A DEA Approach for Evaluating the Efficiency and Effectiveness of Urban Transit Systems." *European Journal of Operational Research*, 152: 354-364
- Kosky, S. 1999. "Performance Evaluation for Rural Transit Systems." RTAP National Transit Resource Center.
- KPH and Associates. 2009. *Rural Transit Achievements: Assessing the Outcomes of Increased Funding for Rural Passenger Services under SAFETEA-LU*. TCRP Project J-6, Task 71.
- Liotine, M., and K. D. Lawrence. 1988. "An Analytical Investigation of Policy Effects on Transit System Performance Measurement." *Socio-Economic Planning Sciences*, 22(4): 185-193.
- Mississippi Department of Transportation (MDOT). 1998. "A Look at Performance Evaluation and Cost Allocation in Public Transit." [http://mdot.ms.gov/portal/Public\\_Transit.aspx](http://mdot.ms.gov/portal/Public_Transit.aspx).
- MDOT State Management Plan. 2011. [http://mdot.ms.gov/portal/Public\\_Transit.aspx](http://mdot.ms.gov/portal/Public_Transit.aspx).
- MDOT. n.d. *Transit Summit Report, Survival Strategies*. [http://mdot.ms.gov/portal/Public\\_Transit.aspx](http://mdot.ms.gov/portal/Public_Transit.aspx).
- National Rural Transit Assistance Program (RTAP) and Community Transportation Association of America (CTAA). 2008. "Status of Rural Transit."
- Neiman, M., and S. Stambough. 1998. "Rational Choice Theory and the Evaluation of Public Policy." *Policy Studies Journal*, 26: 449-65.
- Radow, L., and C. Winters. 1999. "Rural Transit Performance Measures." Technical Assistance Brief #5, RTAP National Transit Resource Center. [www.ctaa.org/.../Rural\\_Transit\\_Performance\\_Measurement.pdf](http://www.ctaa.org/.../Rural_Transit_Performance_Measurement.pdf).
- SAFETEA-LU (Safe, Accountable, Flexible and Efficient Transportation Equity Act—A Legacy for Users), 2005, <https://www.fhwa.dot.gov/safetealu/summary.htm>,
- Sen, L., S. R. Majumdar, M. Highsmith, L. Cherrington, and C. Weatherby. 2012. "Performance Measures for Public Transit Mobility Management." *Compendium of Papers*, Transportation Research Board.
- Stevens, J. P. 2002. *Applied Multivariate Statistics for the Social Sciences* Mahwah, NJ: Lawrence Erlbaum.

- Wall Street Journal. 2008. "Labor Model Predicts Lower Recession Odds." January 28. <http://blogs.wsj.com/economics/2008/01/28/labor-model-predicts-lower-recession-odds/>.
- Winston, C. 2000 "Government Failure in Urban Transportation." *Fiscal Studies*, 21(4): 403-425.
- Wholey, J. S. 2010. "Use of Evaluation in Government: The Politics of Evaluation." In Wholey J. S., H. P. Hatry, and K. E. Newcomer (eds), *Handbook of Practical Program Evaluation*. San Francisco: Jossey Bass.
- Yin, R. K. 2009. *Case Study Research: Design and Methods*, Vol. 5, 4th ed., Applied Social Science Research Methods Series. London: Sage.

### About the Author

**EUNICE V. AKOTO** ([akotov@hsu.edu](mailto:akotov@hsu.edu)) is an Assistant Professor of Public Management at Henderson State University, Arkansas and a co-owner of EDVACO Consulting LLC, a DBE/MBE-certified transit management company. She received her Ph.D. in Public Administration from Jackson State University, a master's degree from The University of Manchester, England, and a B.Ed. from the University of Education of Winneba, Ghana, West Africa. Her experience in transportation spans across her time as a former Eisenhower Transportation Fellow, work with the MDOT's Public Transit Division, serving on TRB's committee on Transit Management and Performance, and consulting with many rural transit agencies. Her research interests include economic and policy impact analysis, transit, and performance management in non-profit and public organizations.

---

# A Taste for Transit? Analyzing Public Transit Use Trends among Youth

Anne E. Brown, Evelyn Blumenberg, and Brian D. Taylor  
UCLA Luskin School of Public Affairs

Kelcie Ralph  
Edward J. Bloustein School of Planning and Public Policy, Rutgers University

Carole Turley Voulgaris  
UCLA Luskin School of Public Affairs

---

## Abstract

*In the past decade, there has been much talk about a decline in driving among youth. This study examined whether this decline is associated with an increased reliance on public transit. To address this issue, 2001 and 2009 National Household Travel Survey (NHTS) data were used to analyze the relationship between age and transit use. Findings indicate that although young adults are more likely to ride transit than older adults, transit use among youth can be explained largely by (1) life cycle factors common among young people but unlikely to persist as they age, (2) higher levels of transit use among non-whites, who are disproportionately young, and (3) locational factors such as living in densely-developed neighborhoods that may or may not continue as young people age. Therefore, whereas transit habits established early in life may persist as young adults age, the data examined here suggest that such an outcome is far from assured.*

**Keywords:** Millennials, transit use, travel behavior

## Introduction

Over the past decade, there has been much talk about a decline in auto travel among youth. Per-capita driving in the U.S. has dipped, with higher than average declines among teens and young adults (or Millennials, those born between 1980 and 2004), prompting some observers to conclude that youth are “ditching” cars for a more multimodal lifestyle that includes a greater reliance on public transit among other non-auto modes (Ball 2014; Blumenberg et al. 2012; Davis, Dutzik, and Baxandall 2012; Malcolm 2014; McDonald 2015). For example, a recent report published by the TransitCenter (2014) concludes, “The Millennial generation seems to be defying its sheltered, suburban upbringing by delaying the acquisition of a driver’s license and choosing transit. Meanwhile, Baby Boomers, who grew up using transit and

were encouraged to do so, are defying their upbringing by avoiding transit now” (TransitCenter 2014, 7).

These trends and conclusions have led to calls for a wholesale shift in transportation infrastructure investments away from new highways toward public transit to better reflect the changing tastes and preferences of young travelers (Inglis and Baxandall 2014). But how, exactly, does age relate to transit use? Will increased transit use among young people persist as youth age into adulthood? In this study, these questions were investigated using data from the 2001 and 2009 National Household Travel Survey (NHTS). First, trends in transit use among young adults from 2001 to 2009 were analyzed, and then a cohort model was developed to examine whether young adults are more likely than older adults to (1) use transit on the survey day and (2) ride transit at least once over the course of a month, controlling for other determinants of transit use (such as individual and household characteristics and the character of the neighborhoods in which they live). In each of these models, the relative influence of cohort effects (birth decade), life cycle effects (such as being a student or having children), or period effects (such as the Great Recession) was assessed. These are important distinctions, because cohort effects tend to persist as the members of a generation age, whereas life cycle effects tend to rise and fall as people move from one life stage to another, and period effects may be short-lived. Distinguishing how these three effects influence transit use among young people will yield insights on whether the Millennial generation’s transit use patterns observed in the 2000s are likely to persist in the decades ahead.

The data on neighborhood characteristics and transit availability are uniquely well-suited for investigating these questions, as data were drawn from the Environmental Protection Agency’s (EPA) Smart Location Database (SLD) and the U.S. Census to develop a transit supply index to measure transit richness for nearly every census tract in the U.S.

### **Millennials and Public Transit—What Do We Know?**

Whereas America’s youth are discussed under many guises, the terms “youth,” “young adults,” and “Millennials” are used interchangeably to refer to those born between 1980 and 2004. Recent research finds that Millennials have a heightened interest in alternative modes of travel, including public transit (Dutzik and Baxandall 2013; TransitCenter 2014), and a growing attraction to highly-urbanized metropolitan areas and neighborhoods in which transit service tends to be most extensive (Urban Land Institute and Belden Russonello Strategists [ULI/BRS] 2013).

Indeed, young adults (under age 30) are more likely to use public transit than older adults and are more enthusiastic about doing so (American Public Transportation Association [APTA] 2015a; McDonald 2015; Rosenbloom and Fielding 1998; TransitCenter 2014). In a recent ULI survey of community attribute preferences, 39% of Millennials (ages 18–36) stated that convenient public transit was important to them, compared to 29% of Baby Boomers (ages 50–68), and 25% of Generation X (ages 37–49) (ULI 2015).

What factors might explain young adult use of and enthusiasm for public transit? Certainly, costs loom large in making mode choice decisions (Blumenberg et al. 2012;



Frank et al. 2008; Rodríguez and Joo 2004). Teens and young adults tend to have less human capital (education and work experience) and correspondingly lower incomes than older adults, which makes younger travelers more sensitive to the high price of transportation options such as car ownership and driving. The personal income of young people tends to increase sharply during their 20s and early 30s (American Community Survey 2008–2012), as does driving (Blumenberg et al. 2012). In APTA's survey of adults ages 22–34, more than half of those who traveled by bus stated that it was “an affordable option for me” (APTA 2013).

Beyond affordability, Millennials may see other personal and societal benefits to using public transit, including the ability to engage in digital socializing while traveling, connecting with their communities, working en route, and reducing the environmental footprint of their travel (APTA 2013). However, findings on how attitudes of public transit vary by age and the effects of age-related attitudes of transit use are ambiguous. For example, the Pew Research Center (2010) finds that Millennials are slightly less likely to exhibit environmentally-conscious behaviors compared to adults in the Generation X and Baby Boomer cohorts. The private subscription car-sharing service Zipcar conducts an annual survey of the attitudes of 18–34 year olds and finds that all urban residents (regardless of age) feel equally strongly about protecting the environment; however, the percentage of those concerned about the environment is substantially higher among city dwellers than among suburban and rural residents (KRC Research 2015). Finally, with respect to technology, researchers do not find a statistically-significant relationship between “a desire to stay connected through communication technologies” and transit use (TransitCenter 2014).

Residential location choices also may explain why youth are more likely than older adults to use public transit. In general, there is a positive and statistically-significant relationship between residential location and transit use, although the causal arrow may run in both directions. First, people who need to travel by public transit (due to low income, physical disability, reluctance to drive, etc.) are likely to locate in neighborhoods in which transit service is good and easy to use. For example, research has shown that low-income households without automobiles tend to be more likely to reside in transit-rich neighborhoods where they can get around more easily using public transit (Glaeser, Kahn, and Rappaport 2008). Although less important than other neighborhood qualities, convenient public transit scores high among the community attribute priorities of low-income households—41% consider it a top or high priority (ULI 2015). As noted above, cost likely plays an important role in the mode choice decisions of youth. Almost 30% of youth ages 16–25 live in households below the poverty line, and almost half live in households below 200% of the poverty line.

For many of the reasons noted above, Millennials may prefer to travel by public transit and, therefore, to live in places where they can more easily do so. Public transit and transit-oriented development (TOD) are central to more urbanized lifestyles. There is some evidence that highly-educated youth—those who are most likely to have a choice in choosing where to live—are slightly more likely to live in urban neighborhoods today than in years past (Cortright 2015; Kolko 2015). Further, two to three times as many



youth (under age 30) as adults (age 30+) report that their “ideal” neighborhood type is in an urban area—either downtown areas with a mix of land use or urban residential neighborhoods (TransitCenter 2014). Similarly, a Nielson (2014) report finds that 62% of Millennials prefer to live in urban mixed-use communities in close proximity to a diverse set of destinations.

Recent research suggests that driving among Millennials has been back on the rise in the years following the Great Recession (Thompson 2015), suggesting that period or cyclical economic factors, rather than a shift in values and preferences, may explain most of the observed decline in driving among youth (Blumenberg et al. 2012). Another recent study finds that the observed decline in youth driving has not been accompanied by a corresponding increase in travel by non-auto modes (McDonald 2015).

Finally, although transit plays a significant role in the centers of the oldest and largest U.S. metropolitan areas, particularly metropolitan New York, the aggregate role of public transit in American life and travel is a small one. Public transit accounted for less than 2% of all person-trips nationwide in 2009. Nationally, there are approximately 43 person-trips by private vehicle for each transit trip, and even in metropolitan areas with populations over 3 million, which are, by far, transit’s richest markets, the ratio of car to transit trips is still 19:1 (APTA 2012; NHTS 2009; Santos et al. 2011).

So what is the relationship between age and transit use? The literature presents conflicting stories.

## **Data and Methodology**

Data from the 2001 and 2009 NHTS were used to analyze transit use over time. Whereas the NHTS includes limited information on stated attitudes and preferences, such as views on safety and the price of travel, it does not directly query respondents on their normative views of public transit, which can help to explain people’s propensity to take transit (Bamberg, Ajzen, and Schmidt 2003). In lieu of stated preferences about transit, the paper focuses on revealed preferences through an analysis of travel behavior. Two outcome measures of transit use were considered—the percent of adults (ages 16+) who (1) used public transit on the survey day and (2) used transit in the past month. Then, a set of statistical models was estimated to assess the influence of three types of effects on the transit outcome measures.

*Life cycle effects* are characteristics associated with particular stages of the life cycle and typically do not “follow” people through the various stages of life (e.g., the presence of children or being a student). The second type of effect considered are *period effects*, which are observable across the two study years, 2001 and 2009. Period effects are events such as an economic recession that affect all population groups.<sup>1</sup> For example, the Great Recession as a period effect is evident in falling employment rates across

---

<sup>1</sup> However, period effects may affect one population group more than others. For example, the recession—a period effect—may have had a larger negative effect on the employment of youth than older adults since, on average, they have less human capital.

older cohorts between 2001 and 2009.<sup>2</sup> Finally, *cohort effects* are the opposite of life cycle effects in that they “follow” groups of similarly-situated people through time. For this analysis, we were particularly interested in whether younger generational cohorts of travelers are more likely to use transit than those in older cohorts who, once accustomed to driving, remain reliant on automobiles as they age. The NHTS data are cross-sectional and do not follow the same individuals over time, so we were not able to directly analyze the behavior of travelers as they age. To work around this data limitation, data were included from both survey years and a series of decade-of-birth (cohort) variables was introduced. Because the sample was restricted to ages 16 and up, the 1990s birth cohort is included only in the 2009 dataset. Thus, the coefficients associated with the 1990s birth decade were interpreted with some caution. Table 1 displays descriptive statistics for the variables included in the model by birth decade cohort and survey year.

**TABLE 1.** Characteristics of Sample Population in 2001 and 2009

Variables	2001					2009				
	Birth Decade Cohort					Birth Decade Cohort				
	1910s-1950s	1960s	1970s	1980s	1990s	1910s-1950s	1960s	1970s	1980s	1990s
<b>Dependent Variables</b>										
% ride transit on travel day	4.0%	5.0%	7.2%	7.4%	-	4.0%	4.5%	5.3%	6.4%	6.5%
% use transit last month	15.3%	18.9%	23.9%	27.4%	-	13.5%	16.5%	18.5%	22.4%	24.9%
<b>Independent Variables</b>										
Race/Ethnicity										
% Non-Hispanic White	77.3%	69.8%	63.5%	66.2%	-	72.9%	70.2%	62.6%	63.5%	66.3%
% Non-Hispanic Black	11.5%	10.4%	11.7%	14.0%	-	13.5%	9.8%	11.4%	10.5%	12.5%
% Hispanic	7.1%	14.0%	19.0%	15.1%	-	9.5%	14.8%	19.3%	19.1%	15.7%
% Other	4.0%	5.8%	5.8%	4.7%	-	4.0%	5.2%	6.8%	6.8%	5.5%
% Employed	57.3%	85.1%	83.8%	63.7%	-	51.1%	79.6%	78.1%	70.6%	42.2%
% Student	0.4%	1.3%	7.4%	44.4%	-	0.2%	0.8%	2.6%	12.1%	53.4%
% Live w/kids	31.2%	62.9%	36.7%	4.6%	-	22.0%	58.4%	45.4%	8.9%	0.5%
% Live w/parents	0.0%	4.8%	15.0%	67.9%	-	0.0%	0.8%	9.2%	46.9%	88.0%
Mean household size	2.6	3.6	3.3	4.0	-	2.3	3.4	3.6	3.6	4.2
Mean residential density	3.3	4.1	4.7	3.4	-	3.5	3.3	4.4	3.7	3.4
Mean transit supply index	0.4	0.5	0.7	0.4	-	0.4	0.5	0.6	0.5	0.3
N	74,992	22,513	14,845	17,696	-	174,369	43,157	25,952	15,389	11,875

The model also included data on travelers’ residential neighborhood characteristics. We controlled for residential density, which numerous studies associate with transit use (Dittmar and Ohland 2004; Guest and Cluett 1976). Finally, a measure of the relative

<sup>2</sup> Interestingly, a higher share of the 1980s cohort was employed in 2009 during the Great Recession than in 2001. But this is almost certainly due to life cycle effects trumping period effects. For example, between 2001 (when the youngest members of this cohort were age 12) and 2009 (when the youngest members were age 20), many individuals in the 1980s cohort aged into employment. Correspondingly, the share of the student population in the 1980s birth cohort declined from 44% in 2001 to 12% in 2009.

supply of public transit in the neighborhood in which respondents live was included. Although transit supply is, to some extent, endogenous to transit demand (Taylor et al. 2009), in this context, the transit supply variable could be viewed as an attribute in residential neighborhood location decisions.<sup>3</sup> Whether the decision to locate in transit-rich or transit-poor neighborhoods reflects life cycle or cohort preferences is uncertain. If people are more likely to live in transit-rich urban neighborhoods when they are young and single, but then are also more likely to move to auto-oriented suburban neighborhoods when they marry and have children, the neighborhood choice would be a life cycle effect. In contrast, if Millennial preferences for transit-rich urban neighborhoods persist as young adults age, then neighborhood choice would be a cohort effect.

To develop the transit supply measure, data from the EPA's SLD and the U.S. Census<sup>4</sup> were used. Transit frequency in the SLD is measured as the "aggregate frequency of transit service within a 0.25-mile radius of a block group boundary per hour during evening peak period" (EPA 2014). In other words, it is measured as the number of vehicles per hour of service per square mile. The measure is less intuitive than other measures (e.g., proximity to a bus stop) and, therefore, should be interpreted as a composite transit service index that captures both the presence and frequency of fixed-route transit service.<sup>5</sup>

The SLD transit supply metric is based on General Transit Feed Specification (GTFS) data. Although GTFS data are available for many transit agencies, not all transit operators collect and report them. Therefore, many places that host public transit service were excluded from the database. To correct for these missing transit data, transit supply for nearly every U.S. Census tract was predicted in an effort that, to our knowledge, has not been previously undertaken for the entire United States. Predicted transit supply was calculated first by selecting variables from the American Community Survey (ACS) and U.S. Census that correlate strongly with reported transit frequency in places in which we had complete transit service data. These data then were used in an ordinary least squares regression model estimated to predict transit supply. The transit supply estimation model predicts approximately 44% of the variance observed in transit frequency ( $R^2=0.44$ ) across tracts with "full" transit data. The model estimates then were used to predict transit frequency for all census tracts in the country, including those for which we had full data. To validate the results, the actual transit service values from the SLD were compared to our predictions. The predicted transit supply levels

---

<sup>3</sup> Because transit supply is, at least partially, endogenous to transit demand, we ran each of the models with and without the transit supply variable. We kept the transit supply variable in the final set of models, given its significance. We note that when the transit supply variable was omitted from the models, the relationships between the dependent and independent variables remained much the same in terms of sign and magnitude. These results are available from the authors upon request.

<sup>4</sup> The EPA's SLD includes more than 90 variables summarizing urban characteristics including housing density, land use, neighborhood design, demographics and employment, and destination accessibility. It also includes data on transit supply at the block group level.

<sup>5</sup> As noted in the SLD User Guide (Ramsey and Bell 2014), the transit data are based on GTFS, a reporting format used by many large transit agencies. The data, therefore, represent the supply of fixed-route transit service. Many tracts without fixed-route transit service still may be served by paratransit.

were moderately right-skewed, which was to be expected since some of the tracts with partial data may have greater transit frequency than reported in the SLD. The robustness of this predicted transit supply measure was tested by running the models described below for the tracts for which we had full transit supply data—once with the actual data and again with the predicted data. The model results varied little between the two data sources, supporting the use of the estimated transit service supply data in the tracts for which we did not have complete data.

As the map in Figure 1 shows, the vast majority of census tracts with transit service are concentrated in the very largest Metropolitan Statistical Areas (MSAs). Although the top 10 MSAs comprise about one-quarter of census tracts in the nation, they account for fully 95% of all census tracts with fixed-route public transit service; metropolitan New York alone accounts for 31% of these transit supply tracts. In addition to the highly-skewed distribution of transit service across metropolitan areas, transit service supply varies substantially across neighborhoods within metropolitan areas as well. To show this, we drew on a neighborhood typology developed in Blumenberg et al. (2015) to analyze transit supply across seven distinct types of neighborhoods, as listed and described in Table 2.

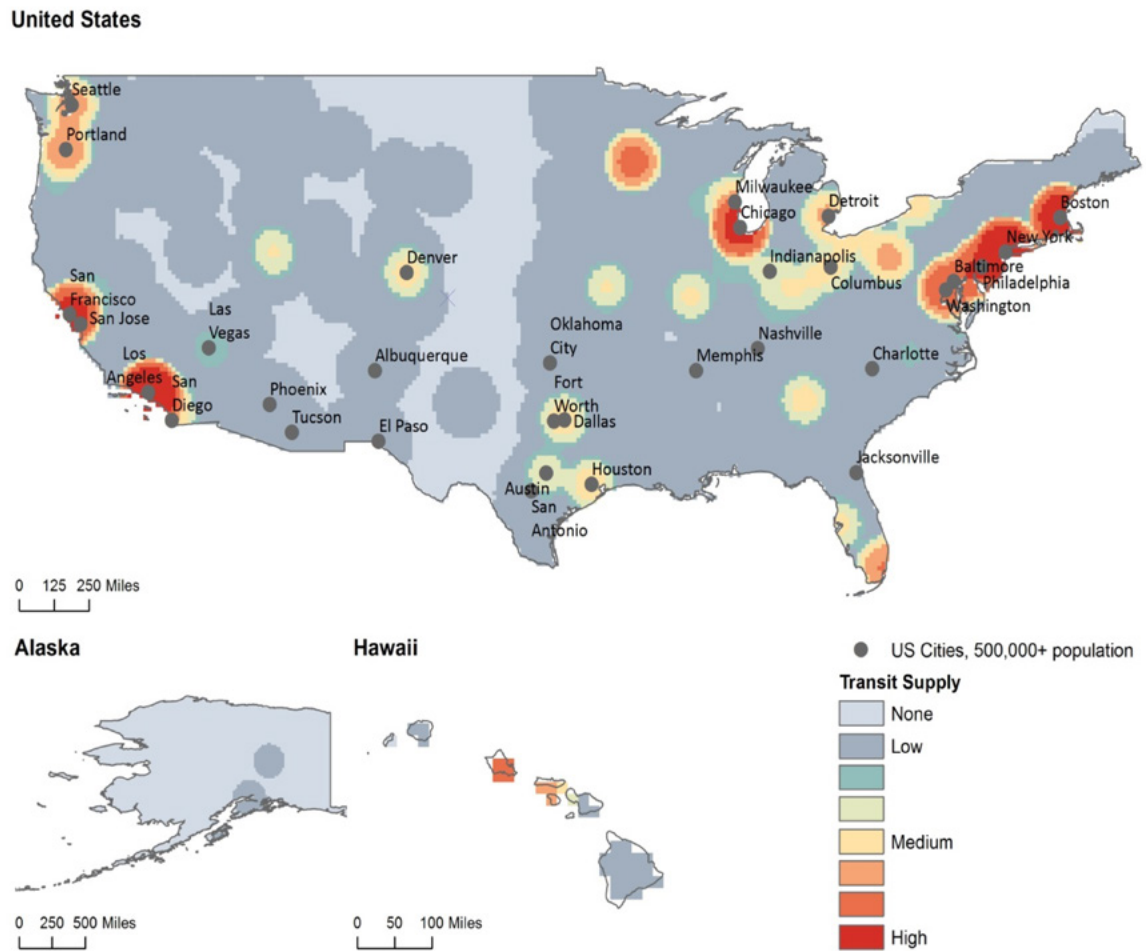


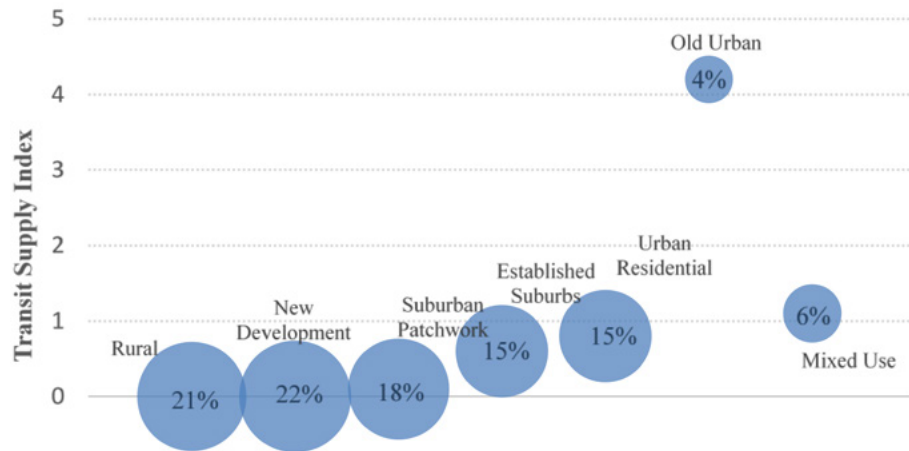
FIGURE 1. Map of U.S. transit supply

**TABLE 2.**  
Neighborhood Types

	Neighborhood Type	Neighborhood Description	Typical Location
1	Mixed-use	Mostly downtowns, plus major outlying office/ industrial districts	Urban-type neighborhoods
2	Old Urban	Densest, least auto-oriented neighborhoods	
3	Residential Urban	Mostly central city residential areas	
4	Established Suburban	Mostly older suburban residential areas	Suburban-type neighborhoods
5	Suburban Patchwork	Largely mixed commercial and residential areas	
6	New Development	Typically newest, most sprawling developments	
7	Rural		Rural areas

As Figure 2 shows, the transit supply index is, by far, the highest in “Old Urban” neighborhoods that are among the most densely-developed in the country, but which comprise only 4% of all U.S. census tracts. In contrast, three in five (6%) census tracts in the U.S.—largely in rural and outlying suburban areas—have little or no transit service.

**FIGURE 2.**  
Transit supply in U.S. by neighborhood type



### How Does Transit Use Vary by Age?

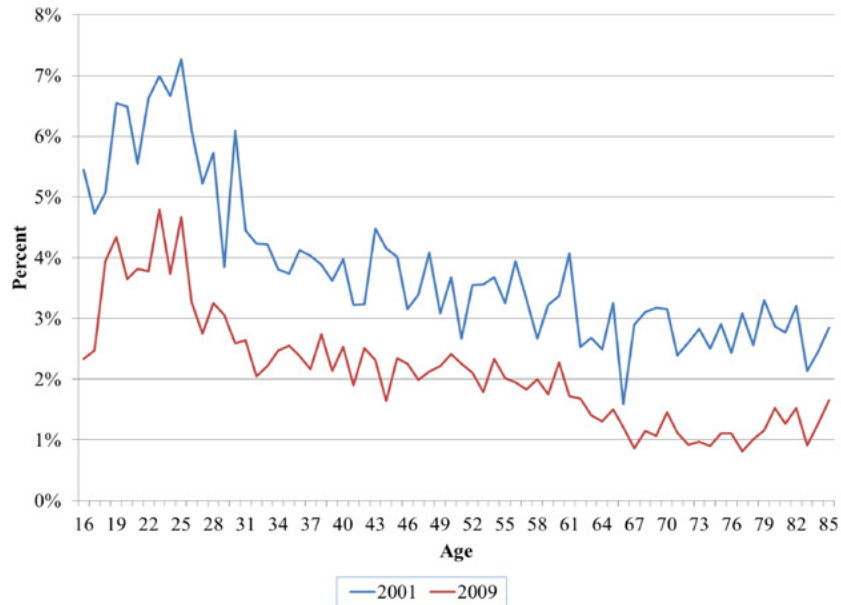
The two figures below reveal four distinct transit use patterns. First, Figure 3, which displays the percentage of the survey population that used transit on the previous day, shows that transit is used by a small share of the U.S. population, less than 8% (age 16 older) used transit on the survey day.

Figure 4 is similar to Figure 3, but shows whether respondents used transit at all over the previous one or two months.<sup>6</sup> The two graphs viewed together suggest a second pattern—that people report “occasionally” using public transit far more than they report using it on the “previous day.” The two figures collectively reveal a third pattern: teens and young adults ride public transit much more frequently than older adults.

<sup>6</sup> The NHTS includes a survey question intended to capture those travelers who ride transit only occasionally. Unfortunately, the question differs between the two survey years. In 2001, respondents were asked whether they used transit in the previous two months, whereas in 2009 they were asked whether they used transit in the last month, making it difficult to compare results directly across the two survey years.

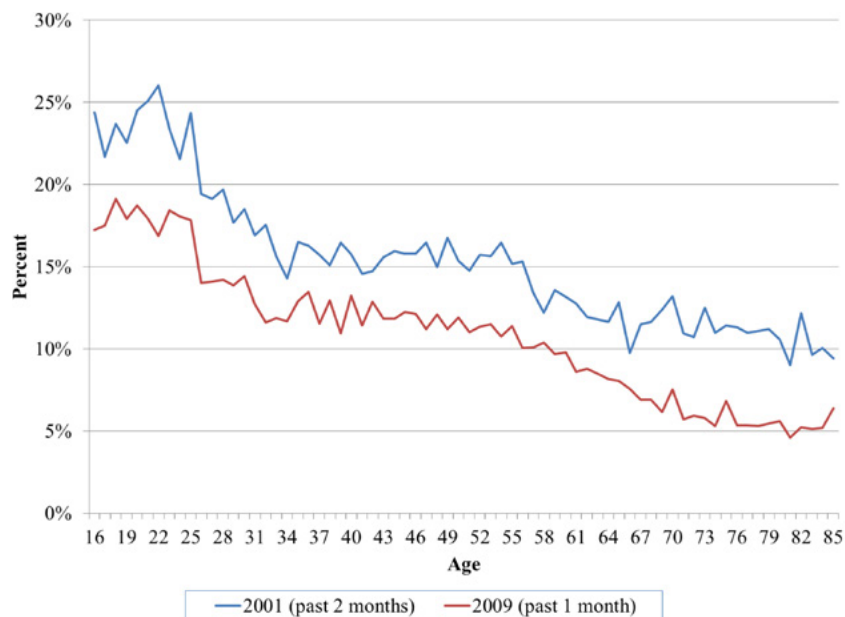
In general, transit use tends to increase from the teens into the mid-20s, but then declines until about age 70.<sup>7</sup> The fact that this same pattern is seen in both survey years suggests a likely life cycle effect on transit use, whereby transit use declines after the mid-20s as people move through various stages of the life cycle.

**FIGURE 3.**  
Percentage using transit on survey day by age and year



Source: NHTS, 2001 and 2009

**FIGURE 4.**  
Percentage using transit in the last 1–2 month(s)



Source: NHTS, 2001 and 2009

<sup>7</sup> In 2009, fewer than 2% of older adults (ages 65+) used transit on the survey day.



What might explain higher transit use among younger adults relative to older adults? For one, lower average incomes tend to be associated with lower levels of automobile access (Pendyala, Kostyniuk, and Goulias 1995). Young adults, on average, are getting driver licenses at a later age than in previous decades (Taylor et al. 2013). And, finally, young adults are more likely to reside in central city, transit-rich neighborhoods (which may be related to both lower incomes and lower levels of automobile access). Nearly 20% of Millennials live in the 10 largest MSAs, which have the highest level of transit supply, compared to about 18% of older adults. As previously noted, urban living may be either a life cycle or cohort effect. If it is mostly a life cycle effect, whereby most urban young adults will “age out” of central-city, transit-rich neighborhoods, then higher levels of transit use are unlikely to persist as youth age through the life cycle; if it is a cohort effect, then transit use among younger riders is more likely to persist with age.

Finally, viewed together, Figures 3 and 4 reveal a fourth, and perhaps surprising, transit use pattern, which strongly suggests either a period or cohort effect on transit use. Transit use declined among all similar-age people between 2001 and 2009. It could be that the Great Recession depressed transit use among all ages in 2009 compared to 2001—a period effect—from which transit use across age cohorts may recover as the economy does. Or it could be that later generations of Americans use transit less than earlier generations did at the same age, which would not bode well for the transit in the future.

While suggestive, these descriptive data offer little insight on the independent effects of these relationships. To help untangle these relationships, a multivariate analysis was employed, as described below.

### **Predicting Transit Use**

To better understand the factors driving transit use in the 2000s, logistic regression models were estimated to simultaneously account for an array of possible factors influencing transit use, including age and the role of birth-decade cohort, independent from other factors. One of the central purposes of this analysis was to determine—after controlling for other determinants of transit use—whether the underlying factors influencing travel are changing over time, and, in particular, if the next generation of American adults will be more or less likely to travel by public transit than previous generations.

Table 3 shows the results of two statistical models. Model 1 is a logistic regression model to predict the likelihood of taking transit on the survey day. Model 2 is a similar model to predict the likelihood of using transit in the prior month(s).<sup>8</sup> After controlling for other factors thought to determine transit use, the cohort effect variables—birth decades—were found to be not statistically-significant predictors of transit use. More recent birth cohorts (younger generations) were no more or less likely to take public transit than older cohorts, with one exception—those born before 1960 were more likely to ride transit the previous month than the youngest generation.

---

<sup>8</sup> Recorded as within one month prior to survey in 2009 and two months prior to the 2001 survey.



**TABLE 3.**  
Factors Predicting Transit Use

Variables	Model 1: Made transit trip on survey day			Model 2: Made transit trip in last month		
	n= 392,175			n= 392,175		
	Coef.	St. Error	Sig.	Coef.	St. Error	Sig.
<b>Individual Characteristics</b>						
Sex (Female=1)	0.04	0.05	NS	-0.04	0.03	NS
Employed	<b>0.32</b>	<b>0.07</b>	<b>***</b>	<b>0.13</b>	<b>0.03</b>	<b>***</b>
Student	<b>0.51</b>	<b>0.12</b>	<b>***</b>	<b>0.47</b>	<b>0.06</b>	<b>***</b>
Age	<b>-0.01</b>	<b>0.01</b>	<b>**</b>	<b>-0.03</b>	<b>0.00</b>	<b>***</b>
<b>Race/Ethnicity (Baseline: Non-Hispanic White)</b>						
Black	<b>0.96</b>	<b>0.08</b>	<b>***</b>	<b>0.34</b>	<b>0.05</b>	<b>***</b>
Hispanic	<b>0.66</b>	<b>0.08</b>	<b>***</b>	<b>0.13</b>	<b>0.05</b>	<b>**</b>
Other	<b>0.65</b>	<b>0.09</b>	<b>***</b>	<b>0.15</b>	<b>0.06</b>	<b>**</b>
<b>Birth Decade (Baseline 1980-1990)</b>						
1910s-1940s	0.07	0.25	NS	<b>0.31</b>	<b>0.12</b>	<b>**</b>
1950s	0.16	0.18	NS	<b>0.28</b>	<b>0.09</b>	<b>***</b>
1960s	0.00	0.15	NS	0.03	0.08	NS
1970s	-0.08	0.12	NS	-0.10	0.06	NS
<b>Household Characteristics</b>						
Live w/kids	<b>-0.30</b>	<b>0.08</b>	<b>***</b>	<b>-0.15</b>	<b>0.04</b>	<b>***</b>
Live w/parents	0.08	0.13	NS	0.08	0.06	NS
Household Size	<b>0.11</b>	<b>0.03</b>	<b>***</b>	<b>0.05</b>	<b>0.01</b>	<b>***</b>
Household Income (\$10,000s)	<b>0.06</b>	<b>0.01</b>	<b>***</b>	<b>0.12</b>	<b>0.01</b>	<b>***</b>
Household Vehicle Count	<b>-1.20</b>	<b>0.05</b>	<b>***</b>	<b>-0.79</b>	<b>0.02</b>	<b>***</b>
<b>Neighborhood Characteristics</b>						
Transit supply	<b>0.04</b>	<b>0.02</b>	<b>**</b>	<b>0.14</b>	<b>0.02</b>	<b>***</b>
Transit supply*age	-0.00	0.00	NS	-0.00	0.00	NS
Residential Density	<b>0.03</b>	<b>0.00</b>	<b>***</b>	<b>0.14</b>	<b>0.01</b>	<b>***</b>
<b>Year (Base: 2001)</b>						
2009	-0.08	0.07	NS	0.01	0.00	NS
Constant	<b>-1.97</b>	<b>0.2</b>	<b>***</b>	<b>-16.46</b>	<b>8.3</b>	<b>**</b>

Note: Regression unit is person; sample: 16 years and older.  
 \*\*\* p<0.01, \*\* p<0.05, \*p<0.1, NS is not statistically significant.  
 Source: 2001 and 2009 NHTS; EPA 2014

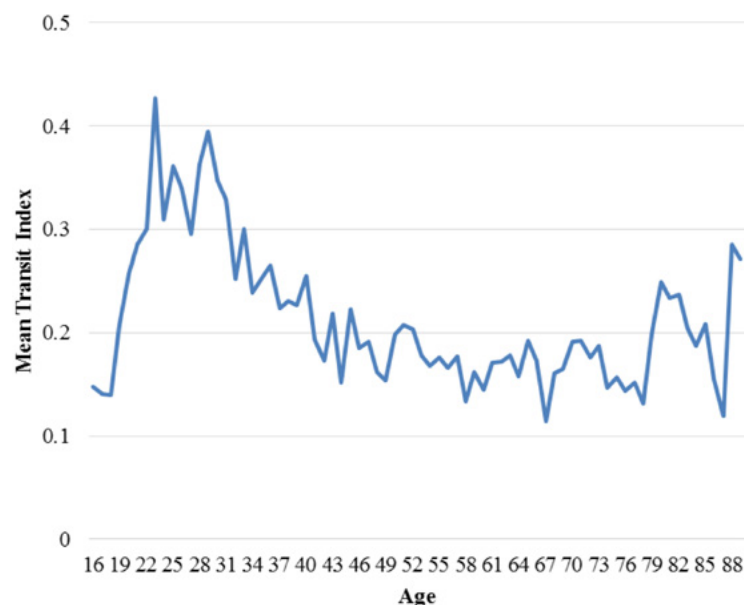
The models also showed that transit use declines with age, a life cycle effect. Additionally, as expected, other life cycle variables had a clear association with transit use. Household composition plays an important role. Adults in households with children are less likely to use transit. This squares with previous research, which finds that households with children are more likely to have complex trip-making patterns that are difficult to accomplish on transit and for which households are more likely to drive (Hensher and Reyes 2000; McGuckin, Zmud, and Nakamoto 2005). In contrast, we found a positive relationship between household size and transit use. This relationship

may be owing to competition among household members for automobiles; for example, Kitamura (1989) found that households with more drivers than cars take transit more than households with equal numbers of drivers and cars. Being a student also was positively related to transit use in both models. This finding is consistent with studies showing a positive relationship between students and transit use and ridership (Khattak et al. 2011; Taylor et al. 2009). Student status is associated with age; on average, students in the sample were 20.8 years old. The relationship between “student status” and transit use likely represents a life cycle effect, one that youth grow out of as they age. It is possible that once students become accustomed to using public transit, they may be more likely to continue using transit as they age (Fujii and Gärling 2005), although this would not explain why transit use is lowest among middle-aged cohorts, at least some of whom presumably rode transit in their younger student years.

Employment may be, in part, a life cycle effect, as it is inversely related to being a student. It was positively related to transit use on the survey day and during the previous month. Although period effects, such as a recession, may exert pressure on life cycle variables such as employment, employment represents an important life cycle transition from school into the workforce. Being a student has a stronger positive effect on transit use than employment, potentially helping to explain decreasing transit use with age.

Neighborhood residential density and transit richness may reflect either a cohort and/or a life cycle effect. This depends on whether youth choose to remain in dense, transit-rich areas or move out of them as they age. If the former, residential location could be interpreted as a cohort effect; if the latter, it acts as a life cycle effect. Currently, Millennials living independently—i.e., without their parents—reside in denser neighborhoods, on average, compared to older adults. Young adults also are more likely to live in tracts with a slightly higher supply of transit compared to older adults (see Figure 5). Both variables—density and transit supply—are positively associated with

**FIGURE 5.**  
Transit-rich neighborhoods  
and resident age, 2009



transit use in all three models. Since the quality of transit service affects all people in a given area and not just teens and young adults, the interaction between transit supply and cohort was tested to understand whether younger cohorts who live in transit-rich areas are more likely to use transit than older cohorts who also live in transit-rich areas. This interaction term was not significant in any of the models and was excluded from the final models. Therefore, the sustained increase in transit use and its relationship to the residential location of Millennials as they age is less about being more likely to ride transit in dense neighborhoods and more about if they will continue to live in dense neighborhoods as they age.

Period effects were not significant in either the survey day or within the past month(s) models. As a final test, whether there was an interaction between generational cohort and survey year was examined to assess if period effects varied across cohorts. These interaction terms were not statistically significant and, therefore, were excluded in the final model.

Finally, it is important to note that the Millennial generation is unique from previous generations in that, in particular, they are disproportionately Hispanic and non-white compared to older generations. Because Hispanic and non-white travelers are more likely to ride transit than are white travelers, transit use may rise with population growth and change. However, even within each race/ethnicity, age and birth decade are not significant predictors of transit use, and younger cohorts are not more likely to ride transit controlling for other factors. Therefore, if average transit use among Millennials remains high even as they age, this is likely more attributable to demographic transitions—a compositional effect—rather than an increasing preference for transit among those within various demographic groups.

These results should be interpreted with two caveats. First, only eight years elapsed between the 2001 and 2009 NHTS, which may be too short to observe lasting cohort effects. Second, the results are muddled by the Great Recession, which bottomed out in 2009. Although period effects were not statistically-significant in the model, the recession undoubtedly affected other variables that influence travel behavior such as employment and income. Future travel data will help to address both these caveats by including a longer sampling frame and post-recession travel data.

## **Conclusion**

Although young adults are indeed more likely to ride public transit than older adults, little evidence was found in the data analyzed that these patterns reflect a waxing embrace of transit that may be expected to persist as teens and young adults age, as suggested by some observers. After controlling for factors such as age (a life cycle variable), employment and student status, race/ethnicity, income, household living situation, auto availability, and residential location, essentially no statistically-significant independent effects of generational birth cohort on transit use were observed. Transit use among young adults also does not appear to be directly related to period effects operationalized in this analysis as 2001 and 2009, although it is acknowledged that the period effects may be reflected in changes in other variables.

These findings suggest that although young adults are more likely than older adults to ride transit, their higher use is due to (1) life cycle factors common among young people (such as being a student, not yet having children, having a lower income), (2) demographic factors (such as being a racial/ethnic minority), and (3) locational factors (such as living in densely-developed, transit-rich neighborhoods). It is possible that as the U.S. population continues to become more diverse and if racial/ethnic minorities continue to use transit more frequently than white riders as they age, then elevated levels of transit use may persist among these groups. But there is no guarantee of this; for example, research on travel among immigrants suggests that transit use declines with years living in the U.S. (Blumenberg and Smart 2011). Likewise, if younger adults remain in urban areas as they age, then these aging adults may remain loyal transit users. Although this is certainly possible, it is by no means guaranteed. In sum, this paper finds that although Millennials, on average, may express a greater preference for transit than members of older generations, these preferences do not manifest in transit use greater than what would otherwise be explained by factors unrelated to either age or generational status.

What do the findings regarding youth suggest for public transit in the years ahead? Governments large and small have made substantial financial commitments to expanding public transit service in recent years; both service levels and, especially, public expenditures have grown dramatically. In the first decade of the 21st century, inflation-adjusted revenue vehicle miles of service increased by 34% and revenue vehicle miles by 29%. Total public expenditures on transit service increased even faster during this time period—total inflation-adjusted transit capital and operating expenses rose by 72% overall and 58% per passenger trip (APTA 2015b).

Although transit patronage was up during the 2000s, it rose at a far slower rate than either transit service or (especially) expenditures. Overall transit use was up 9% during the decade and passenger miles of travel rose 1%, both roughly the same as the increases in the U.S. population living in metropolitan areas—11% (Wilson et al. 2012).

Despite increases in expressed preferences for public transit among youth and significant increases in transit service and public expenditures on the mode, per-capita transit ridership actually was down slightly (-2%) during the 2000s. The national transit data presented in Table 4 square with the NHTS transit data examined in this analysis: between 2000 and 2009, the percentage of the population that rode transit on an average day dipped from 5.1 to 4.9% (NHTS 2001, 2009).<sup>9</sup>

---

<sup>9</sup> This change is not statistically significant at a 95% level of confidence.

**TABLE 4.**  
Transit Service and Ridership,  
2000–2010

Aggregate Statistics	2000 (in millions)	2010 (in millions)	Percent Change
Metropolitan population	233	258	11%
Unlinked passenger trips	9,363	10,218	9%
Passenger miles	47,666	54,012	13%
Vehicle revenue miles	3,613	4,837	34%
Vehicle revenue hours	246	317	29%
Total capital and operating expense*	\$32,233	\$55,579	72%
<b>Adjusted Measures</b>			
Unlinked passenger trips per capita	40.2	39.6	-2%
Passenger miles per capita	204.5	209.1	2%
Passengers per vehicle revenue mile	2.6	2.1	-19%
Passengers per vehicle revenue hour	38.1	32.2	-16%
Capital and operating expense per passenger trip*	\$3.44	\$5.94	58%

\*Inflation adjusted to 2009 dollars.

Source: APTA 2015b; Wilson et al. 2012

Collectively, the data presented in Table 4 point to a recent renaissance in transit provision and expenditure, but not in transit use or, especially, service productivity. Further, the data analyzed in this study suggest that heightened levels of transit use among teens and young adults are far from assured to persist as they begin to age. In concert, these data suggest that transit agencies cannot count on Millennials to stem the recent declines in transit productivity on their own.

Instead, concerted efforts to motivate increased transit use and improve transit service attractiveness likely will be required to keep Millennials in the transit riding habit. Improving transit service frequency and reliability are common barriers to transit use among riders of all ages and are important to rider satisfaction (Beirão and Cabral 2007; Cain 2006; Yoh et al. 2011). Targeted transit investments that increase transit reliability and accessibility could make transit more adaptable to a wide variety of travelers and trips and, thus, be more amenable to life cycle changes such as increased trip chaining with the presence of children. Such improved transit service could enable Millennials to do what previous generations have not, and what Millennials themselves do not appear poised to do on their own, which is to continue to use transit as they age.

## References

- American Community Survey. 2008–2012. *5-Year American Community Survey*.
- American Public Transportation Association (APTA). 2012. *2012 Public Transportation Fact Book Appendix A: Historical Tables*. [www.apta.com](http://www.apta.com).
- APTA. 2013. *Millennials & Mobility. Understanding the Millennial Mindset*. [www.apta.com](http://www.apta.com/resources/statistics/Documents/FactBook/2015-APTA-Fact-Book-Appendix-A.pdf). <http://www.apta.com/resources/statistics/Documents/FactBook/2015-APTA-Fact-Book-Appendix-A.pdf>.

- APTA. 2015a. *2015 APTA Transit Fact Book*. <http://www.apta.com/resources/statistics/Pages/transitstats.aspx>.
- APTA. 2015b. *2015 Public Transportation Fact Book*, Appendix A Historical Tables. [www.apta.com](http://www.apta.com).
- Ball, J. 2014. "The Proportion of Young Americans Who Drive Has Plummeted—and No One Knows Why." *The New Republic*, March 12.
- Bamberg, S., I. Ajzen, and P. Schmidt. 2003. "Choice of Travel Mode in the Theory of Planned Behavior: The Roles of Past Behavior, Habit, and Reasoned Action." *Basic and Applied Social Psychology*, 25(3): 175-187.
- Beirão, G., and J. S. Cabral. 2007. "Understanding Attitudes Towards Public Transport and Private Car: A Qualitative Study." *Transport Policy*, 14(6): 478-489.
- Blumenberg, E., A. Brown, K. Ralph, B. D. Taylor, and C. T. Voulgaris. 2015. "Typecasting Neighborhoods and Travelers: Analyzing the Geography of Travel Behavior among Teens and Young Adults in the U.S." <http://tinyurl.com/obneh8w>.
- Blumenberg, E., and M. Smart. 2011. "Migrating to Driving: Exploring the Multiple Dimensions of Immigrants' Automobile Use." In Lucas, K., R. Weinberger, and E. Blumenberg, *Auto Motives: Understanding Car Use Behaviours*. Bingley, UK, Emerald: 225-252.
- Blumenberg, E., B. D. Taylor, M. Smart, K. Ralph, M. Wander, and S. Brumbagh. 2012. "What's Youth Got to Do with It? Exploring the Travel Behavior of Teens and Young Adults." UCLA.
- Cain, A. 2006. "Teenage Mobility in the United States: Issues and Opportunities for Promoting Public Transit." *Transportation Research Record*, 1971: 140-148.
- Cortright, J. 2015. "Twenty-Somethings are Choosing Cities. Really." <http://cityobservatory.org/twenty-somethings-are-choosing-cities-really/>.
- Davis, B., T. Dutzik, and P. Baxandall. 2012. "Transportation and the New Generation: Why Young People are Driving Less and What It Means for Transportation Policy." [http://www.ssti.us/wp/wp-content/uploads/2012/04/Transportation\\_and\\_the\\_New\\_Generation.pdf](http://www.ssti.us/wp/wp-content/uploads/2012/04/Transportation_and_the_New_Generation.pdf).
- Dittmar, H., and G. Ohland. 2004. *The New Transit Town: Best Practices in Transit-Oriented Development*. Island Press.
- Dutzik, T., and P. Baxandall. 2013. "A New Direction: Our Changing Relationship with Driving and the Implications for America's Future." <http://www.uspirg.org/sites/pirg/files/reports/A%20New%20Direction%20vUS.pdf>.
- Environmental Protection Agency. 2014. Smart Location Database. <http://www2.epa.gov/smart-growth/smart-location-mapping>.
- Frank, L., M. Bradley, S. Kavage, J. Chapman, and T. K. Lawton. 2008. "Urban Form, Travel Time, and Cost Relationships with Tour Complexity and Mode Choice." *Transportation*, 35(1): 37-54.

- Fujii, S., and T. Gärling. 2005. "Temporary Structural Change: A Strategy to Break Car-Use Habit and Promote Public Transport." Paper presented at the International Conference of Traffic and Transport Psychology.
- Glaeser, E. L., M. E. Kahn, and J. Rappaport. 2008. "Why do the Poor Live in Cities? The Role of Public Transportation." *Journal of Urban Economics*, 63(1): 1-24.
- Guest, A. M., and C. Cluett. 1976. "Analysis of Mass Transit Ridership Using 1970 Census Data." *Traffic Quarterly*, 30(1).
- Hensher, D. A., and A. J. Reyes. 2000. "Trip Chaining as a Barrier to the Propensity to Use Public Transport." *Transportation*, 27(4): 341-361.
- Inglis, J., and P. Baxandall. 2014. "Highway Boondoggles: Wasted Money and America's Transportation Future." <http://www.uspirg.org/sites/pirg/files/reports/HighwayBoondogglesUSPIRG.pdf>.
- Khattak, A., X. Wang, S. Son, and P. Agnello. 2011. "Travel By University Students in Virginia: Is This Travel Different from Travel by the General Population?" *Transportation Research Record*, 2255: 137-145.
- Kitamura, R. 1989. "A Causal Analysis of Car Ownership and Transit Use." *Transportation*, 16(2): 155-173.
- Kolko, J. 2015. "Why Millennials Are Less Urban than You Think." *FiveThirtyEight Economics*. <http://fivethirtyeight.com/features/why-Millennials-are-less-urban-than-you-think/>.
- KRC Research. 2015. "Millennial is a State of Mind – Zipcar 2015 Millennial Survey Results [Press release]. [http://www.slideshare.net/Zipcar\\_PR/zipcar2015-millennialmind-slideshare/1](http://www.slideshare.net/Zipcar_PR/zipcar2015-millennialmind-slideshare/1).
- Malcolm, H. 2014. "Millennials Prefer Cities with Good Public Transit." *USA Today*, April 24.
- McDonald, N. C. 2015. "Are Millennials Really the "Go-Nowhere" Generation?" *Journal of the American Planning Association*, 81: 90-103.
- McGuckin, N., J. Zmud, and Y. Nakamoto. 2005. "Trip-Chaining Trends in the United States: Understanding Travel Behavior for Policy Making." *Transportation Research Record*, 1917: 199-204.
- NHTS. 2001. 2001 National Household Travel Survey. <http://nhts.ornl.gov>.
- NHTS. 2009. 2009 National Household Travel Survey. <http://nhts.ornl.gov>.
- Nielson. 2014. "Millennials – Breaking the Myths." [http://www.nielsen.com/content/dam/corporate/us/en/reports-downloads/2014 Reports/nielsen-millennial-report-feb-2014.pdf](http://www.nielsen.com/content/dam/corporate/us/en/reports-downloads/2014%20Reports/nielsen-millennial-report-feb-2014.pdf).
- Pendyala, R. M., L. P. Kostyniuk, and K. G. Goulias. 1995. "A Repeated Cross-Sectional Evaluation of Car Ownership." *Transportation*, 22(2): 165-184.



- Pew Research Center. 2010. "Millennials. A Portrait of Generation Next. Confident. Connected. Open to Change." <http://www.pewsocialtrends.org/files/2010/10/Millennials-confident-connected-open-to-change.pdf>.
- Ramsey, K., A. Bell. 2014. *Smart Location Database. Version 2.0 User Guide*. [http://www2.epa.gov/sites/production/files/2014-03/documents/sld\\_userguide.pdf](http://www2.epa.gov/sites/production/files/2014-03/documents/sld_userguide.pdf).
- Rodríguez, D. A., J. Joo. 2004. "The Relationship between Non-Motorized Mode Choice and the Local Physical Environment." *Transportation Research Part D: Transport and Environment*, 9(2): 151-173.
- Rosenbloom, S., G. J. Fielding. 1998. *Transit Markets of the Future: The Challenge of Change*. Transportation Research Board.
- Santos, A., N. McGuckin, H. Y. Nakamoto, D. Gray, and S. Liss. 2011. Summary of Travel Trends: 2009 National Household Travel Survey. <http://nhts.ornl.gov/2009/pub/stt.pdf>.
- Taylor, B. D., D. Miller, H. Iseki, and C. Fink. 2009. "Nature and/or Nurture? Analyzing the Determinants of Transit Ridership across U.S. Urbanized Areas." *Transportation Research Part A: Policy and Practice*, 43(1), 60-77.
- Taylor, B. D., K. Ralph, E. Blumenberg, and M. Smart. 2013. "Who Knows About Kids These Days? Analyzing Determinants of Youth and Adult Mobility between 1990 and 2009." Paper presented at the Transportation Research Board 92nd Annual Meeting.
- TransitCenter. 2014. "Who's On Board. Mobility Attitudes Survey." <http://transitcenter.org/ourwork/mobility-attitudes-survey/>.
- Thompson, D. 2015. "Not So Cheap, After All." *The Atlantic*, April 21.
- Urban Land Institute. 2015. "America in 2015. A ULI Survey of Views on Housing, Transportation, and Community." <http://uli.org/wp-content/uploads/ULI-Documents/America-in-2015.pdf>.
- Urban Land Institute & Belden Russonello Strategists (ULI/BRS). 2013. "Americans' Views on their Communities, Housing, and Transportation." <http://www.uli.org/wp-content/uploads/ULI-Documents/America-in-2013-Final-Report.pdf>.
- Wilson, S. G., D. A. Plane, P. J. Mackun, T. R. Fischetti, and J. Goworowska, J. 2012. "Patterns of Metropolitan and Micropolitan Population Change: 2000 to 2010." <http://www.census.gov/prod/cen2010/reports/c2010sr-01.pdf>.
- Yoh, A., H. Iseki, M. Smart, and B. Taylor. 2011. "Hate to Wait: Effects of Wait Time on Public Transit Travelers' Perceptions." *Transportation Research Record*, 2216: 116-124.

## **About the Authors**

**ANNE E. BROWN** (*aebrown0316@ucla.edu*) is an Urban Planning Ph.D. student at UCLA; her research focuses on travel behavior, transportation finance, and transportation and economic outcomes.

**EVELYN BLUMENBERG** (*eblumenb@g.ucla.edu*) is Professor and Chair of Urban Planning at the University of California, Los Angeles; her research focuses on access to opportunity among low-income households.

**BRIAN D. TAYLOR** (*btaylor@g.ucla.edu*) is Director of the Institute of Transportation Studies and Lewis Center for Regional Policy Studies at UCLA; his research centers on travel behavior, transportation finance, social equity, and public transit.

**KELCIE RALPH** (*kelcie.r@gmail.com*) is an Assistant Professor in the Bloustein School of Planning and Public Policy at Rutgers; her research centers on travel behavior, bicycling, and environmental policy.

**CAROLE TURLEY VOULGARIS** (*caroleturley@ucla.edu*) is an Urban Planning Ph.D. student at UCLA, where she studies transportation planning and funding decisionmaking and its influence on individual and household travel behavior.

---

# Journey towards World Class Stations: An Assessment of Platform Amenities at Allahabad Junction

Geetika, Piyali Ghosh, Mohit Kumar Ojha, and Sumit Kumar  
Motilal Nehru National Institute of Technology

---

## Abstract

Passengers spend considerable time on railway platforms using amenities thereon; thus, making their stay pleasurable would result in passenger satisfaction for a rail journey. The Ministry of Railways in India has initiated plans for developing stations of world-class standards by delivering state-of-the-art facilities and quality services at platforms. This paper is an attempt to assess levels of importance and satisfaction perceived by passengers with respect to amenities on platforms of Allahabad Junction in the State of Uttar Pradesh, India. A total of 32 platform amenities examined through a sample of 1,248 passengers were grouped under 7 factors using Exploratory Factor Analysis. A service quality performance matrix was prepared thereafter to identify amenities needing improvement, and a Customer Satisfaction Index was calculated to determine a priority order for improvement of these amenities. Security and cleanliness were revealed to be the aspects that need improvement. Findings of this study are expected to be useful for policymakers working on the concept of world-class stations.

**Keywords:** Passenger satisfaction, Indian Railways, Allahabad Junction, railway platform, world class stations, service quality performance matrix

## Introduction

Movement of people and materials between places is a necessary corollary of modern life. People have to travel from one place to the other to satisfy their personal, professional, psychological, social, religious, recreational, and other needs. Considering these aspects, public transport is regarded as a long-term solution for mobility (Hanumappa et al. 2015). Rail is a preferred mode of transportation in India for various reasons, such as its wide network, accessibility, affordability, and ease of travel. However, in spite of being considered as a barometer of the country's economic growth, Indian Railways has lost market share in its freight and passenger segment due to lack of customer responsiveness and poor public perception (Railway Board 2009). Especially

when it comes to quality of service, concerns arise about rail, be it in the context of quality of transit or rail coaches or railway platforms. Problems such as overcrowding, unauthorized vending, lack of amenities, waiting lounges, access control, and passenger guidance systems (Sharma 2009) result in an unpleasant stay for passengers and adversely affect their satisfaction with their rail journey.

Customer satisfaction is a state of mind (Juran 1998), a cumulative construct that is a function of service expectations and performance perceptions in a given period of time (Samen et al. 2012). In the context of transportation, passenger satisfaction is created by comparing pre-travel expectations and post-travel experiences (Gronroos 1988, cited from Guirao et al. 2015; Lei and Chen 2010). The quality of stations has a positive impact on the overall perception of passengers about a rail journey (Givoni and Rietveld 2007), and provision of adequate and quality services help in making a passenger's stay pleasurable (Dash, Dash, and Pradhan 2012). Considering the passenger base of Indian Railways and the considerable portion of travel time spent by passengers on platforms, it is important that amenities available at platforms match passenger expectations to ensure their satisfaction and make their experience pleasurable.

This study draws motivation from a perceived need to conduct exploratory research on railway stations to assess the level of passenger satisfaction with amenities available at platforms and ascertain which amenities need improvement. For this purpose, a study of Allahabad Division was undertaken. Allahabad is the headquarters of the North Central Railway Zone of Indian Railways. It has 1 junction station and 8 satellite stations, and the junction has 10 platforms to cater to 2 of the busiest routes, New Delhi-Howrah and Mumbai-Howrah.

This study applied the concept of a service quality performance matrix proposed by Hung, Huang, and Chen (2003) on Indian Railways to measure the satisfaction level of passengers with amenities at platforms in the first step, and a customer satisfaction index (CSI) (Yang 2003; Giannoccaro et al., 2008) was constructed in the next step to prioritize amenities that need improvement. This methodology marks a departure from earlier studies on Indian Railways, especially in the context of specific amenities available at railway platforms; thus, it contributes to the body of literature on public transportation, especially railways.

The next section discusses the relevance of the study, followed by a summary of extant literature on passenger satisfaction from amenities at railway platforms. The research plan adopted, an analysis of data, and conclusions and recommendations are presented next. The last section summarizes the limitations of the study and highlights a scope for further research.

## **Relevance of the Study**

There are two main components of rail travel—the passenger stay on a platform for boarding or alighting from a train and the stay in trains. A railway platform is an important component of factors such as reliability, service, and information concerns of railways; this is because information and facilities provided at platforms constitute part of the service before and after a trip and can cause delay and reliability issues

(Pettersson 2011). Therefore, improving amenities available at platforms plays a vital role in enhancing the performance of the service provider in meeting passenger expectations from an entire trip. Hence, the focus in this study was on determining passenger satisfaction levels with various amenities at platforms and their relative perceived importance levels to get an insight into the gap between the importance and satisfaction levels of individual amenities and to suggest areas for improvement in order of priority.

The relevance of this research and the choice of Allahabad Junction to assess platform amenities can be explained from two perspectives, the first of which is the concept of world-class stations. In 2006, Indian Railways identified 16 metro and mini stations to be developed into world-class stations with modern facilities and a high-quality appearance. Pursuant to the Vision-2020 document promulgated by the Ministry of Railways, Government of India, for modernization of rail services, the list was extended in 2012 and includes Allahabad Junction. Commitment to the purpose of world-class stations is evidenced by the fact that the Ministry allocated Rs. 10,000 billion with the objective of redeveloping stations and logistic parks, which is around 12% of the proposed investment plan for 2015–19 ([www.indianrailways.gov.in](http://www.indianrailways.gov.in)).

Second, by including aspects of cleanliness and hygiene in measuring satisfaction and importance, the present study finds relevance in the wake of the flagship program of the Government of India to embark on a nationwide cleanliness drive, Swachh Bharat Abhiyan, which has motivated Indian Railways to launch the Swachh Rail–Swachh Bharat mission towards providing and maintaining a clean and hygienic environment not only in trains but also at railway stations.

The outcome of this research might provide a framework to policymakers and planners in redeveloping railway stations that meet world-class standards.

## **Review of the Literature**

Several studies on railways have attempted to measure passenger satisfaction level with amenities available at platforms and in trains. For example, Le-Klähn, Hall, and Gerike (2015) ascertained passenger satisfaction with public transportation including suburban trains, underground trains, trams, and local buses in Munich, Germany. Factor analysis yielded four service dimensions—traveling comfort, service quality, accessibility, and additional features contributing to passenger satisfaction. Evaluating railway services in Indonesia, Pratminingsih, Rudatin, and Suhardi (2014) considered the constructs of perceived quality, perceived value, trust, satisfaction, and passenger loyalty and concluded that all have significant positive inter-relationships and lead to overall passenger satisfaction. Esmaeili, Manesh, and Golshan (2013) established a significant relationship of service quality with customer satisfaction and customer loyalty and between customer satisfaction and customer loyalty in their study of stations in Tehran. A report by the Gallup Organization (2011) based on a study spanning several European countries showed that customers are most satisfied with the aspects of ease of buying tickets, provision of information about train schedules/platform, and personal security in stations. Facilities for car parking, the quality of facilities and services, and cleanliness/good maintenance of station facilities were the major dissatisfiers.

Evaluating rail services at Coimbatore Junction in India, Gandhimathi and Saravanan (2013) suggested seven factors that are important for passenger satisfaction. According to passenger ratings, comfort, tangibles, and assurance were the top three factors, followed by empathy, frequency, speed, and reliability. In an empirical investigation of Indian Railways by Sheeba and Kumuthadevi (2013), 16 variables for measuring passenger satisfaction were grouped under 7 factors—basic facilities, hygiene, safety and security, catering, health care services, punctuality, and behavior towards passengers.

Gupta and Dutta (2012) took the case of Howrah Junction and prioritized reduction in waiting time, upgrading of security systems, upgrading of travel-associated facilities, improvement in passenger amenities, improvement in accessibility, and enhancement of information availability as the physical and functional requirements of passengers. Geetika and Nandan (2010) identified 16 parameters for measuring the passenger satisfaction level with services at platforms in a study of Allahabad Junction that were further grouped into 5 factors—refreshment, behavior, information system efficiency, basic facility, and security. Of these, quality of refreshment and behavior of staff were found to be the most significant predictors. In another study on Indian Railways, Agarwal (2008) considered 47 attributes to assess the effect of consumer perceptions about different service aspects of public transportation services on their satisfaction level; customer-oriented basic platform services was the most important factor, followed by employee behavior (Gupta and Dutta 2012).

## **Objectives of the Study**

This study aimed to ascertain the importance–satisfaction paradigm of amenities available at railway platforms. The first objective, therefore, was to measure passenger satisfaction from such amenities considering platforms at Allahabad Junction. The second objective was to determine the passenger perception about the importance levels of the respective amenities to highlight the gap between levels of importance and satisfaction. For this purpose, a service quality performance matrix was developed to analyze importance–satisfaction gaps. To prioritize amenities for improvement, a customer satisfaction index was calculated. The outcome of this paper is a set of various categories of platform amenities in the importance–satisfaction relationship.

## **Research Plan**

This study was empirical in nature based on primary data, and a questionnaire-based survey method was used for data collection. The population of passengers being of a floating nature, a judgmental sampling technique was used per the number of footfalls on platforms. To address possible limitations of this technique, the survey spanned a period of 7 days at all 10 platforms of Allahabad Junction during different time periods; this helped to contact varied types of passengers coming from or going to various parts of the country.

An exhaustive list of 46 amenities was prepared as an outcome of a preliminary investigation of platforms at Allahabad Junction and was included in a structured questionnaire used for collecting data from passengers on these amenities on the basis of two aspects: their importance as perceived by respondent passengers and satisfaction

level with such amenities. To measure responses, a five-point Likert-type scale was used. In total, 1,250 questionnaires were completed using a personal interaction method. At the end of the survey, 1,248 questionnaires were found to be complete and usable, thereby registering a response rate of 99.84%.

Extant literature provides evidence of a large number of factors that are significant predictors of passenger satisfaction with a rail journey and/or amenities at platforms. Satisfaction is a comprehensive and broad concept that includes service quality, price, and personal and situational factors (Zeithaml and Bitner 1996). It is also related to affective judgments (Choi et al. 2004; Chen 2008). Exploratory Factor Analysis (EFA) was conducted on all 46 amenities to determine those amenities that are important from the passenger perspective. To measure satisfaction level, only those amenities that were identified by EFA were considered. A service quality performance matrix was constructed in the next step to identify amenities on which the Ministry of Railways needs to define its improvement action plans for delivering maximum satisfaction to passengers.

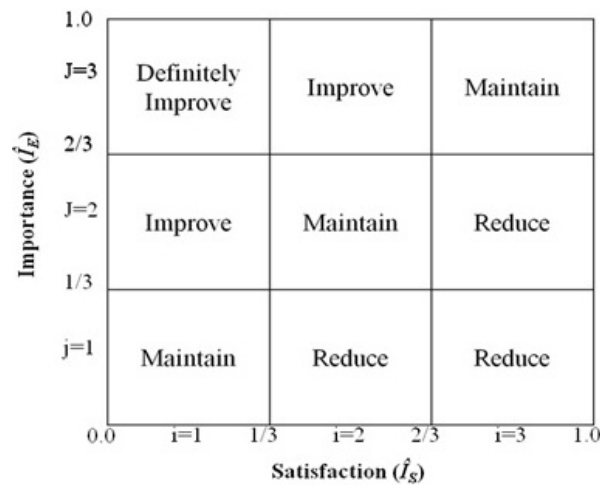
The service quality performance matrix (Figure 1) is a 3×3 matrix with 9 performance zones. The original matrix was developed by Lambert and Sharma (1990) and redeveloped by Hung, Huang, and Chen (2003). Importance and satisfaction indices were calculated using the following formula given by Chen et al. (2007):

$$\text{Index of Importance} = \frac{\mu_I - \text{min}}{R} \quad (1)$$

$$\text{Index of Satisfaction} = \frac{\mu_S - \text{min}}{R} \quad (2)$$

where  $\mu_I$  and  $\mu_S$ , represent means of importance and satisfaction levels, respectively; min indicates the minimum of the scale used in this study; and R is the full range of the scale, i.e., highest–lowest.

**FIGURE 1.**  
Service quality performance matrix



Source: Hung, Huang, and Chen 2003



The indices used are decimal numbers between 0 and 1, and the matrix is divided into three equal intervals using four scales—0.0, 1/3, 2/3, and 1.0. The three equal intervals of 0.0–1/3, 1/3–2/3, and 2/3–1.0 represent low satisfaction/importance, moderate satisfaction/importance, and high satisfaction/importance zones, respectively. The nine zones formed in the matrix are divided into four regions—Definitely Improve (Low Satisfaction–High Importance Zone or LS–HI); Improve, with two zones (Low Satisfaction–Moderate Importance or LS–MI and Moderate Satisfaction–High Importance or MS–HI); Maintain, with three zones (Low Satisfaction–Low Importance or LS–LI, Moderate Satisfaction–Moderate Importance or MS–MI, and High Satisfaction–High Importance or HS–HI); and Reduce, with three zones (Moderate Satisfaction–Low Importance or MS–LI, High Satisfaction–Low Importance or HS–LI, and High Satisfaction–Moderate Importance or HS–MI).

However, if some items lie on the borderline between different zones, it becomes difficult to give recommendations for such items. Further, identifying items only that need improvement is not enough; the priority order of items to be improved must be determined (Chen et al. 2007). Hence, to deal with the difficulty of deciding on a particular zone for items falling on a borderline, it was assumed that items were in the Improvement zone if they were on the border of the Improvement and Maintain zones and in the Maintain zone if they were on the border of Maintain and Reduce.

Second, since the service quality performance matrix does not define any priority order of amenities for improvement, a Customer Satisfaction Index (CSI) was computed. If the service provider organization has abundant resources at its disposal, it can plan its improvement actions for all items that need improvement. But when resources are scarce, which usually is the case, it has to select items for improvement, because it is then neither feasible nor advisable for the organization to invest in each and every item. Hence, the service provider has to determine priority, i.e., which items need to be improved first and which can be improved later. Following this rule, it would first take up items falling in the Improvement zone and, in next step, would assign priority to such items for their improvement. To determine the priority for improvement of each individual item falling in the Improvement zone in the service quality performance matrix, CSI was calculated using the following formula:

$$CSI_i = I_i \times S_i$$

where,  $CSI_i$  is the Customer Satisfaction Index for  $i^{th}$  item,  $I_i$  is the mean of the importance score given by the respondent for  $i^{th}$  item, and  $S_i$  is the mean of the satisfaction score given by the respondent for  $i^{th}$  item. The lower the CSI, the higher the priority for improvement of a particular item, because a low CSI indicates that the gap between the importance score and the satisfaction score is high for that item.

## **Analysis of Data**

### ***Results of Exploratory Factor Analysis***

A KMO value of 0.568 being more than 0.5 (Field 2009) verifies sample adequacy for factor analysis. Bartlett's test of sphericity provides an acceptable value of 12,180 at a 5% level of significance. While conducting EFA, principal component analysis with

Varimax rotation was used, and after applying a cut-off of 0.51 on factor loadings, the rotated component matrix reduced the selected 46 amenities to 32 items grouped under 7 factors, accounting for 65.215% of the total variance (see Table 1) and named as passenger amenities, cleanliness, safety & security, access to station premises, waiting time, announcement system, and other amenities.

**TABLE 1.**  
Total Variance Explained

Component	Initial Eigenvalues			Extraction Sums of Squared Loadings			Rotation Sums of Squared Loadings		
	Total	% of Variance	Cumulative %	Total	% of Variance	Cumulative %	Total	% of Variance	Cumulative %
1	14.219	31.598	31.598	14.219	31.598	31.598	5.796	12.880	12.880
2	4.069	9.042	40.640	4.069	9.042	40.640	5.053	11.229	24.109
3	3.079	6.841	47.481	3.079	6.841	47.481	4.997	11.104	35.213
4	2.407	5.350	52.831	2.407	5.350	52.831	3.781	8.403	43.616
5	2.194	4.876	57.707	2.194	4.876	57.707	3.715	8.255	51.871
6	1.774	3.943	61.650	1.774	3.943	61.650	3.500	7.777	59.648
7	1.604	3.565	65.215	1.604	3.565	65.215	2.505	5.567	65.215

Extraction Method: Principal Component Analysis

Table 2 shows the factors with their respective factor loadings.

**TABLE 2.**  
Factors and Factor Loadings

Factors	Cronbach Alpha	Dimensions	Factor Loadings	Mean (Importance Level)
1 Passenger Amenities	0.894	Refreshment quality	0.778	4.47
		Refreshment affordability	0.692	4.39
		Fans at platforms	0.633	4.27
		Lighting at platforms	0.621	4.48
		Drinking water	0.607	4.52
		Waiting room	0.58	4.55
		Washroom facility	0.541	4.4
		Platform display	0.533	4.35
2 Cleanliness	0.892	Cleanliness in washrooms	0.887	4.58
		Cleanliness near seating chairs	0.842	4.58
		Cleanliness near waiting room	0.757	4.53
		Cleanliness at platforms	0.664	4.56
		Cleanliness near refreshment stalls	0.662	4.55
		Cleanliness near water points	0.647	4.68
		Cleanliness on tracks	0.598	4.29
3 Safety & Security	0.897	Security of self	0.756	4.42
		Police assistance booths (GRP)	0.696	4.47
		Security of luggage	0.694	4.35

Factors	Cronbach Alpha	Dimensions	Factor Loadings	Mean (Importance Level)
4 Access to Station Premises	0.791	Two-wheeler parking space	0.766	3.89
		Availability of foot-over bridges	0.678	4.11
		Four-wheeler parking space	0.672	3.76
		Accessibility of station on foot	0.669	3.92
		Accessibility of other modes of transportation	0.643	4.08
		Availability of escalators	0.533	4.03
5 Waiting Time	0.653	Waiting time at enquiry counter	0.546	4.19
		Waiting time for travel related information	0.529	3.95
6 Announcement System	0.842	Clarity of announcement	0.796	4.45
		Accuracy of announcement	0.777	4.45
7 Other Amenities	0.658	Internet facilities	0.732	3.77
		ATMs	0.664	4.31
		Mobile charging points	0.647	4.16
		Cloak room	0.609	3.79

- **Factor 1 (Passenger Amenities)** ( $\alpha=0.894$ ) – Provision of amenities such as waiting room, drinking water, and washrooms is a basic requirement of passengers at platforms, and their satisfaction with rail travel was found to depend on the availability of these amenities. This is in consonance with the findings of previous studies (e.g., Rahman and Rahman 2009; Geetika and Nandan 2010; Sheeba and Kumuthadevi 2013).
- **Factor 2 (Cleanliness)** ( $\alpha=0.892$ ) – Cleanliness as a service dimension has been a subject and outcome of several studies, especially in the context of railways. For example, cleanliness was one of the service quality attributes of passenger rail systems in the U.S. identified by Drea and Hanna (2000).
- **Factor 3 (Safety & Security)** ( $\alpha=0.897$ ) – Social safety is an important element considered necessary for passengers to feel comfortable at railway platforms while waiting (Cavana, Corbett, and Lo 2007; Rahman and Rahman 2009; Van Hagen 2011, cited from Vos 2013). People may even choose not to travel by public transportation if they do not feel safe in such an environment (Atkins 1990; Van't Hof 2008, cited from Vos 2013).
- **Factor 4 (Access to Station Premises)** ( $\alpha=0.791$ ) – Passengers expect appropriate provisions for accessing railway platforms. Our findings correspond to the study of Cavana, Corbett, and Lo (2007), in which connectivity was established as an important factor affecting passenger perception of service quality.
- **Factor 5 (Waiting Time)** ( $\alpha=0.653$ ) – Passengers expect timely provision of services and prefer not to wait too long for their delivery. Factor analysis reveals

that the extent of waiting contributes towards the satisfaction level of travelers. A similar finding was reported by Sheeba and Kumuthadevi (2013).

- **Factor 6 (Announcement System)** ( $\alpha=0.842$ ) – This factor has two dimensions, clarity and accuracy. Appropriate and timely information is what passengers expect from railways, and information emerged as an important predictor of passenger satisfaction in earlier studies (e.g., Cavana, Corbett, and Lo 2007; Rahman and Rahman 2009; Geetika and Nandan 2010; Swami and Parida 2015).
- **Factor 7 (Other Amenities)** ( $\alpha=0.658$ ) – Various amenities under this factor include cloak room, ATMs, mobile charging points, and internet facilities on platforms.

### Service Quality Performance Matrix

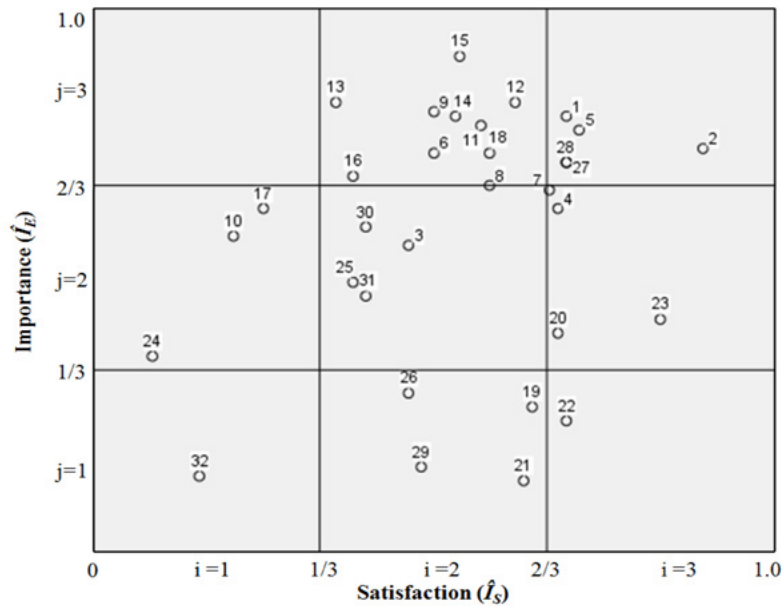
To construct the service quality performance matrix, first, the importance and satisfaction indices were calculated for the 32 amenities that emerged from the EFA, using equations 1 and 2 (Table 3). Coordinates for each amenity then were mapped in the performance matrix (Figure 2).

**TABLE 3.**  
Importance and Satisfaction  
Index

	Amenities	Mean (Importance Level)	Mean (Satisfaction Level)	Importance Index ( $\hat{I}_E$ )	Satisfaction Index ( $\hat{I}_S$ )
1	Waiting room	4.55	3.31	0.887500	0.5775
2	Lighting at platforms	4.48	3.63	0.870000	0.6575
3	Fans in platforms	4.27	2.94	0.817500	0.4850
4	Platform display	4.35	3.29	0.837500	0.5725
5	Drinking water	4.52	3.34	0.880000	0.5850
6	Refreshment quality	4.47	3.00	0.867500	0.5000
7	Refreshment affordability	4.39	3.27	0.847500	0.5675
8	Washroom facility	4.40	3.13	0.850000	0.5325
9	Cleanliness at platforms	4.56	3.00	0.890000	0.5000
10	Cleanliness on tracks	4.29	2.53	0.822500	0.3825
11	Cleanliness near waiting room	4.53	3.11	0.882500	0.5275
12	Cleanliness near seating chairs	4.58	3.19	0.895000	0.5475
13	Cleanliness in washrooms	4.58	2.77	0.895000	0.4425
14	Cleanliness near refreshment stalls	4.55	3.05	0.887500	0.5125
15	Cleanliness near water points	4.68	3.06	0.920000	0.5150
16	Security of self	4.42	2.81	0.855000	0.4525
17	Security of luggage	4.35	2.6	0.837500	0.4000
18	Police assistance booths (GRP)	4.47	3.13	0.867500	0.5325
19	Accessibility of station on foot	3.92	3.23	0.730000	0.5575

	Amenities	Mean (Importance Level)	Mean (Satisfaction Level)	Importance Index ( $\hat{I}_E$ )	Satisfaction Index ( $\hat{I}_S$ )
20	Accessibility of other modes of transportation	4.08	3.29	0.770000	0.5725
21	Four-wheeler parking space	3.76	3.21	0.690000	0.5525
22	Two-wheeler parking space	3.89	3.31	0.722500	0.5775
23	Availability of foot-over bridges	4.11	3.53	0.777500	0.6325
24	Availability of escalators	4.03	2.34	0.757500	0.3350
25	Waiting time at enquiry counter	4.19	2.81	0.797500	0.4525
26	Waiting time for travel-related information	3.95	2.94	0.737500	0.4850
27	Clarity of announcement	4.45	3.31	0.862500	0.5775
28	Accuracy of announcement	4.45	3.31	0.862500	0.5775
29	Cloak room	3.79	2.97	0.697500	0.4925
30	ATMs	4.31	2.84	0.827500	0.4600
31	Mobile charging points	4.16	2.84	0.790000	0.4600
32	Internet facilities	3.77	2.45	0.692500	0.3625

**FIGURE 2.**  
Service quality performance matrix calculations



It is evident from Figure 2 that of the 32 amenities, 14 fall in the Definitely Improve and Improve regions, 10 in Maintain, and 8 in Reduce. Analyzing the nine zones, it can be concluded that none of the amenities falls in the LS–HI zone (Definitely Improve), and only one (internet facility) is in the LS–LI zone. The HS–LI zone also has only one amenity (two-wheeler parking space), and five amenities (waiting room, lighting at platforms, drinking water, clarity of announcement, and accuracy of announcement) are located in HS–HI zone. Of these, only lighting at platforms is at the extreme corner; the

remainder are near the borderline. Thus, it is concluded that passenger satisfaction is moderate for the majority of amenities.

Maximum amenities (refreshment quality, refreshment affordability, washroom facility, cleanliness at platforms, cleanliness near waiting room, cleanliness near seating chairs, cleanliness in washrooms, cleanliness near refreshment stalls, cleanliness near water points, security for self, and police assistance booths) are located in the MS–HI zone, indicating that passengers are moderately satisfied with most of the amenities that are important to them. Zone LS–MI has only three amenities (cleanliness on tracks, security of luggage, and availability of escalators) that are moderately important for passengers, and their satisfaction level is on the lower side. For the four amenities located in the MS–MI zone (fans in platforms, waiting time at enquiry counters, ATMs, and mobile charging points), the satisfaction level is on par with the level of importance. Platform display, accessibility of other modes of transportation, and availability of foot-over bridges are in the HS–MI zone, and accessibility of station on foot, four-wheeler parking space, waiting time for travel-related information, and cloak room are in the MS–LI zone, which shows that, in all, there are seven amenities with which the satisfaction level of passengers exceeds their importance level. Two amenities, refreshment affordability and washroom facility, are on the border of the MS–MI and HS–MI zones and the MS–HI and MS–MI zones, respectively, which implies that a concentrated effort could check the location of these amenities in the lower zone.

#### **Customer Satisfaction Index (CSI)**

Priority-wise, items for improvement per the CSI (see Table 4) are availability of escalators, cleanliness on tracks, security of luggage, security of self, cleanliness in washrooms, refreshment quality, cleanliness at platforms, washroom facility, cleanliness near refreshment stalls, police assistance booths, cleanliness near waiting room, cleanliness near water points, refreshment affordability, and cleanliness near seating chairs.

**TABLE 4.**  
Priority List of Items for Improvement

	Amenities	Customer Satisfaction Index
1	Availability of escalators	9.43
2	Cleanliness on tracks	10.85
3	Security of luggage	11.31
4	Security of self	12.42
5	Cleanliness in washrooms	12.68
6	Refreshment quality	13.41
7	Cleanliness at platforms	13.68
8	Washroom facility	13.77
9	Cleanliness near refreshment stalls	13.87
10	Police assistance booths	13.99
11	Cleanliness near waiting room	14.09
12	Cleanliness near water points	14.32
13	Refreshment affordability	14.36
14	Cleanliness near seating chairs	14.61



## **Conclusions and Recommendations**

### **Conclusions**

This paper has identified amenities available at railway platforms that are significant for passenger satisfaction and has indicated amenities that need improvement and that need to be maintained. Improvement is required related to cleanliness (at platforms and washrooms; near waiting rooms, seating chairs, refreshment stalls, and water points; and on tracks), security of self and luggage, police assistance booths, refreshment quality and affordability, and availability of escalators. Ten amenities emerged that need to be maintained at their current levels. It can be concluded that aspects related to cleanliness and security are areas of concern, as all amenities under these two heads lie in the Improvement region. Of the 14 amenities that need to be improved on a priority basis, 10 are in the categories of cleanliness and security. Further, of top five items in the improvement priority list, two each are from the broad categories of cleanliness and security.

A train journey is more than the time spent inside the train; hence, railway operators must provide state-of-the-art services to customers even before they buy a ticket and until they reach their final destination (Pettersson 2011). Results presented herein give a clear picture with respect to Allahabad Junction and highlight the prioritization of improvements needed there to ensure a higher level of passenger satisfaction. These findings corroborate with the concerns of railway authorities regarding cleanliness, linking “Swachh Rail” with the “Swachh Bharat” drive.

### **Recommendations**

To promote the ongoing nationwide cleanliness drive, Indian Railways announced a new department for cleanliness in its Railway Budget 2015–16. Therefore, efforts must be intensified to accomplish the mission of Swachh Rail–Swachh Bharat. Further, amenities such as accessibility of stations on foot, four-wheeler parking space, two-wheeler parking space, waiting time for travel-related information, and cloak rooms were found to have moderate to high levels of satisfaction in this study, but their importance is rated low. Therefore, it is recommended that the Ministry of Railways curtail funds from these amenities and divert them to other amenities that are high on the importance scale but have a low satisfaction level. For the remaining amenities, the Ministry of Railways should maintain the current status of service delivery because the satisfaction level of passengers equals their corresponding importance level.

The next aspect that needs immediate attention on the part of Ministry of Railways is security mechanism at platforms. Provision of safety measures such as body and luggage scanners, metal detectors, CCTV cameras (equipped with facial recognition technology), and fire detection and suppression systems, as proposed by the Ministry (Railway Board 2009) at every railway station, is expected to enhance the safety and security of passengers at platforms. According to Crime Concern (2002), researchers in the United Kingdom concluded that a sense of safety and security among passengers in trains and at stations is likely to result in an additional 10.5% in train trips (Currie, Delbosc, and Mahmoud 2013). Studies have established that people usually feel unsafe in public transportation areas; this underlines the significance of lighting in the context

of safety at railway platforms (Vos 2013). Johansson, Rosein, and Kuler (2011) suggest that bright, evenly-distributed, and monotone lights produce the highest feelings of safety. Thus, lighting at platforms as an amenity under Factor 1 (Passenger Amenities) can be linked with Factor 3 (Safety & Security). Enhancement of social safety also can be an outcome of establishing a clean environment at railway platforms (Vos 2013).

Providing good quality food at platforms is of immense importance. Findings showed that the quality and affordability of refreshments at Allahabad Junction are in Improvement zone (MS-HI) in the service quality performance matrix, thus causing dissatisfaction. Refreshments aid in the mitigation of the discomfort of passengers waiting at platforms (Geetika and Nandan 2010). Indian Railways should offer refreshment stalls and conduct surprise visits and inspections for continuous evaluation of service performance, including quality and price of refreshments offered by vendors.

### **Limitations of the Study and Scope for Further Research**

This paper is based on a survey conducted at one railway station, and findings could differ if more stations are included. The perceptions of passengers, condition of platforms, levels of satisfaction, etc., could vary depending upon the level of development of the respective state/city. This study has not considered the opinions of respondent-passengers on satisfaction/dissatisfaction. Further research on assessment of specific reasons for dissatisfaction of passengers with selected amenities is welcomed.

### **References**

- Abu-ELSamen, A., M. N. F. Akroush, A. L. Al-Sayed, and H. J. Hasan, H. J. 2012. "An Empirical Model of Customer Service Quality and Customer Loyalty in an International Electronics Company." *International Journal of Electronic Business*, 10(1): 39-63.
- Agarwal, R. 2008. "Public Transportation and Customer Satisfaction: The Case of Indian Railways." *Global Business Review*, 9(2): 257-72.
- Atkins, S. T. 1990. "Personal Security as a Transport Issue, a State of the Art Review." *Transportation Reviews*, 10(2): 111-125.
- Campell, D. T., and D. W. Fiske. 1959. "Convergent and Discriminant Validation by the Multi Trait-Multi Method Matrix." *Psychological Bulletin*, 56(2): 81-105.
- Cavana, R. Y., L. M. Corbett, and Y. L. Lo. 2007. "Developing Zones of Tolerance for Managing Passenger Rail Service Quality." *International Journal of Quality & Reliability Management*, 24(1): 7-31.
- Chen, C. F. 2008. "Investigating Structural Relationships between Service Quality, Perceived Value, Satisfaction, and Behavioral Intentions for Air Passengers: Evidence from Taiwan." *Transportation Research Part A*, 42(4): 709-717
- Chen, S. H., C. C. Yang, W. T. Lin, and T. M. Yeh. 2007. "Service Quality Attributes Determine Improvement Priority." *The TQM Magazine*, 19(2): 162-175.

- Choi, K. S., W. H. Cho, S. Lee, H. Lee, and C. Kim. 2004. "The Relationships among Quality, Value, Satisfaction and Behavioral Intention in Health Care Provider Choice: A South Korean Study." *Journal of Business Research*, 57(8): 913-921.
- Crime Concern. 2002. "People Perceptions of Personal Security and Their Concerns about Crime on Public Transport: Literature Review." London, UK: Department for Transport.
- Currie, G., A. Delbosc, and S. Mahmoud. 2013. "Factors Influencing Young Peoples' Perceptions of Personal Safety on Public Transport." *Journal of Public Transportation*, 16(1): 1-19.
- Dash, S., S. R. Dash, and S. K. Pradhan. 2012. "Measuring Service Quality of Railway Platforms in India: A Case-Study of East-Coast Railways." *International Journal of Research in Computer Application & Management*, 2(12): 129-134.
- Drea, J. T., and J. B. Hanna. 2000. "Niche Marketing in Intrastate Passenger Rail Transportation." *Transportation Journal*: 33-43.
- Esmaili, A. A., B. A. Manesh, and E. Golshan. 2013. "Service Quality, Customer Satisfaction and Customer Loyalty in RAJA Rail Transportation Company." *International Research Journal of Applied and Basic Sciences*, 4(12): 4248-4253.
- Field, A. 2009. *Discovering Statistics using SPSS*. London: Sage Publications Ltd.
- Gallup Organization. 2011. *Survey on Passengers' Satisfaction with Rail Services*. Hungary: European Commission.
- Gandhimathi, S., and S. Saravanan. 2013. "A Study on Passenger's Satisfaction towards Railway Services in Coimbatore Junction." *International Journal of Applied Research and Studies*, 2(11): 1-6.
- Geetika and S. Nandan. 2010. "Determinants of Customer Satisfaction on Service Quality: A Study of Railway Platforms in India." *Journal of Public Transportation*, 13(1): 97-113.
- Giannoccaro, R., N. Costantino, A. D. Ludovico, and R. Pietroforte. 2008. "Measuring Citizen Satisfaction with Aspects of Public Services from a Local Authority and Determining Their importance: A Case Study." *Public Organization Review*, 8(1): 1-15.
- Givoni, M., and P. Rietveld. 2007. "The Access Journey to the Railway Station and Its Role in Passengers' Satisfaction with Rail Travel." *Transport Policy*, 14: 357-365.
- Grönroos, C. 1988. "Service Quality: The Six Criteria of Good Service Quality." In *Review of Business*. New York: St. John's University Press.
- Guirao, B., A. Garcia, M. E. López, and C. Acha. 2015. "New QR Survey Methodologies to Analyze User Perception of Service Quality in Public Transport: The Experience of Madrid." *Journal of Public Transportation*, 18(3): 71-81.
- Gupta, S., and R. Datta. 2012. "Prioritizing Service Attributes for Quality Up Gradation of Indian Railway Stations." *The TQM Journal*, 24(2): 167-180.

- Hall, A. L., and R. C. Rist. 1999. "Integrating Multiple Qualitative Research Methods." *Psychology and Marketing*, 16(4): 291-304.
- Hanumappa, D., P. Ramachandran, T. G. Sitharam, and S. Lakshmana. 2015. "Performance Evaluation of Bangalore Metropolitan Transport Corporation: An Application of Data Envelopment Analysis." *Journal of Public Transportation*, 18(2): 1-19.
- Hung, Y. H., M. L. Huang, and K. S. Chen. 2003. "Service Quality Evaluation by Service Quality Performance Matrix." *Total Quality Management and Business Excellence*, 14(1): 79-89.
- Johansson, M., M. Rosén, and R. Küller. 2011. "Individual Factors Influencing the Assessment of the Outdoor Lighting of an Urban Footpath." *Lighting Research and Technology*, 43: 31-43.
- Juran, G. 1998. *Juran's Quality Handbook* (5th ed.). New York, NY: McGraw-Hill.
- Lambert, D. M., and A. Sharma. 1990. "A Customer-Based Competitive Analysis for Logistics Decisions." *International Journal of Physical Distribution & Logistics Management*, 20(1): 17-24.
- Lai, W. T., and C. F. Chen. 2011. "Behavioral Intentions of Public Transit Passengers—The Roles of Service Quality, Perceived Value, Satisfaction and Involvement." *Transport Policy*, 18(2): 318-325.
- Le-Klähn, D. T., C. M. Hall, and R. Gerike. 2014. "Analysis of Visitor Satisfaction with Public Transport in Munich." *Journal of Public Transportation*, 17(3): 68-85.
- Pettersson, P. 2011. "Passenger Waiting Strategies on Railway Platforms – Effects of Information and Platform Facilities: Case Study Sweden and Japan." Master of Science Thesis, Stockholm.
- Pratminingsih, S. A., C. L. Rudatin, and A. R. Suhardi. 2014. "Retaining Passengers Loyalty in Indonesia Railway Service." *Journal of Global Management*, 7(1): 60-75.
- Railway Board. 2009. "Indian Railways." White paper for Railway Board Publication.
- Railway Board. 2015. "Indian Railway Budget Speech 2015–16." Retrieved March 2015 from [http://www.indianrailways.gov.in/railwayboard/uploads/directorate/finance\\_budget/Budget\\_2015-16/Railway\\_Budget\\_Speech\\_2015-16%20\(English\).pdf](http://www.indianrailways.gov.in/railwayboard/uploads/directorate/finance_budget/Budget_2015-16/Railway_Budget_Speech_2015-16%20(English).pdf).
- Rajeswari, V., and K. S. Kumari, K. S. 2014. "Satisfaction and Service Quality in Indian Railways-A Study on Passenger Perspective." *IOSR Journal of Economics and Finance*, 4(1): 58-66.
- Sharma, A. K. 2009. "Modernization of Railway Stations in India: A Case for Public-Private Partnership with Special Reference to New Delhi Railway Station." *South Asian Journal of Management*, 16(1): 102-116.
- Sheeba, A. A., and K. Kumuthadevi. 2013. "Service Quality of South Indian Railway—Determinants of Passenger Satisfaction in Trains." *International Journal of Business and Management Invention*, 2(2): 49-54.

- Swami, M., and M. Parida. 2015. "Comparative Appraisal of Metro Stations in Delhi using Data Envelopment Analysis in a Multimodal Context." *Journal of Public Transportation*, 18(3): 29-51.
- Van Hagen, M., A. Pruyn, M. Galetzka, and J. Sauren. 2010. "Music at Railway Stations: The Influence of Music on Waiting Experience." Presentation at European Transport Conference, 2010.
- Van't Hof, K. 2008. "Circling Safety. Feeling (un)Safe at Railway Stations." Master's thesis, University of Twente, Enschede.
- Vos, L. 2013. "The Effects of Lighting and Disorder on the Perception of Social Safety of Waiting Passengers at a Railway Station Platform." Master's thesis, University of Twente, Enschede.
- Yang, C. C. 2003. "Improvement Actions Based on the Customers' Satisfaction Survey." *Total Quality Management and Business Excellence*, 14(8): 919-930.
- Zeithaml, V. A., and M. J. Bitner. 1996. *Services Marketing*. New York, NY: McGraw-Hill.

## About the Authors

**GEETIKA** ([geetika@mnnit.ac.in](mailto:geetika@mnnit.ac.in)) is a Professor in the School of Management and Dean of Academic Affairs at Motilal Nehru National Institute of Technology, Allahabad, and an Adjunct Professor at the Asian Institute of Technology in Thailand. Her research interests lie in the areas of strategic management and entrepreneurship. She has co-authored 5 books and more than 60 research papers published in national and international journals and has guided more than 10 doctoral students.

**PIYALI GHOSH** ([piyali2602@gmail.com](mailto:piyali2602@gmail.com)) is an Assistant Professor with the School of Management Studies at Motilal Nehru National Institute of Technology in Allahabad. Her research interests lie in industrial relations and training & development. She has co-authored books on managerial economics and industrial relations & labor law for McGraw Hill Education and has published more than 25 research papers in national and international journals.

**MOHIT KUMAR OJHA** ([mohitojha.kr@gmail.com](mailto:mohitojha.kr@gmail.com)) is a Research Scholar in the School of Management Studies at Motilal Nehru National Institute of Technology in Allahabad. He is working in the area of railway station modernization through public-private partnerships as his doctoral research. His areas of specialization include finance and marketing, and his research interest lies in strategic management.

**SUMIT KUMAR** ([sumit.mnitian@gmail.com](mailto:sumit.mnitian@gmail.com)) is an MBA student in the School of Management Studies at Motilal Nehru National Institute of Technology. His areas of specialization include finance and marketing.

---

# Willingness to Use a Public Bicycle System: An Example in Nanjing City

Peiyu Feng and Wenquan Li  
Southeast University, China

---

## Abstract

*The purpose of this paper is to examine the influence factors on willingness to use a public bicycle system and to analyze the impact of each. Ordered Logit and Probit models were used to analyze the change in user willingness after improvements were made. Data were collected from a random survey conducted in September and October 2014 in Nanjing, China. The findings of this research indicate seven factors that most influence willingness to use a public bicycle system, including socioeconomic factors and journey restrictions. Socioeconomic factors (gender, employment, and car ownership) have more impact on user willingness than journey restrictions. In addition, socioeconomic and station facility considerations have the greatest impact on increasing the probability of users being “very willing” to use a public bicycle system.*

**Keywords:** *Public bicycle system, influential factors, users’ willingness to choose the public bicycle system*

## Introduction

Today, China is faced with severe traffic congestion, environmental pollution, and other urban problems. Therefore, Chinese government decision-makers strongly advocate for the development of multimodal “green” transportation systems. Transit priority allows public transportation to be a more attractive option for commuters and has been proposed as a national strategy to reduce people’s increasing reliance on automobiles (State Council 2012). Public bicycles, which have significant advantages for short journeys and easily connect to other public transportation systems, also can be used as a complementary and alternative form of public transit system to solve the “last mile” problem in China’s public transportation model.

Between 2010 and 2014, about 25 new public bicycle systems were implemented annually in China. Based on available data, until February 2014, these systems operated approximately 425,000 public bicycles and 16,105 public bicycle stations and had 4,362,879 bike-sharing members in China. Like China, many cities in Europe and North America have developed public bicycle systems, which have become increasingly popular.



To date, studies of public bicycle systems have been focused on policies, layout, and deployment. Demaio (2009) shows a history of bike-sharing, starting with the first generation “white bike” in 1965. Shaheen et al. (2010) summarized the benefits of bike sharing as providing flexible mobility, reducing traffic congestion, reducing emissions, providing individual financial savings, and supporting multimodal transport connections. Rainer-Harbach et al. (2013) state that a general variable neighborhood search (VNS) with an embedded variable neighborhood descent (VND) is necessary to redistribute bicycles in a public bicycle system. The research of Raviv et al. (2012) presents an inventory model suited for the management of such bicycle systems.

Other researchers have examined factors associated with public bicycle system usage. Bachand-Marleau et al. (2012) found that convenience and avoidance of bike theft and maintenance are key factors in the use of the BIXI bike sharing programs in Montreal. Convenience emerged as the primary importance factor for public bicycle system use in studies published in recent years. Another factor directly associated with convenience is the distance between user homes and the closest docking station. However, these recent studies did not focus on willingness to use a public bicycle system. Research on this topic can help with the forecasting and scheduling of user demands and is important for researching the optimization of public bicycle docking stations and public bicycle system management.

A review of the literature (Hensher et al. 2010; dell’Olio et al. 2010) shows that Ordered Logit and Probit models can be used as discrete choice models that more efficiently characterize different transport systems qualities. These often are carried out with ordered scales of data, as this is an essential characteristic in determining the dependent variable of Ordered Logit and Probit models.

The goal of this paper is to examine the influential variables and their relevance to willingness to use a public bicycle system based on discrete choice models (Ordered Logit and Probit models) using data from Nanjing, China, where public bicycle system use (Figure 1) is on the rise and innovative public bicycle system planning has taken place in recent years.



FIGURE 1. Public bicycle system in Nanjing

## Methodology

Discrete choice models are based on random utility, which provides information on an individual's behavior when faced with a choice and subjected to certain socioeconomic characteristics and journey constraints (Ortuzar and Willumsen 2011). Dell'Olivo et al. (2010) used discrete choice models to research the overall quality of a bus transit system. These models also were used to study user satisfaction with a transport service (Givoni and Rietveld 2007). User willingness to use the public bicycle system examined in this paper looks at how users perceive the quality of the service being provided by the public bicycle based on whether they score themselves as "very willing," "willing," "unwilling," or "very unwilling" to use the public bicycle system. This choice-making is the evaluating process according to a range of possibilities on an ordered scale and also meets with the discrete choice modeling process.

Hensher et al. (2010) and dell'Olivo et al. (2010) showed that an Ordered Logit and Progit model can be used as a discrete choice model; it has been used to arrange the qualifications and levels in the definition and research of user choice willingness for the public bicycle system in this paper.

The Ordered Logit and Probit model is defined as (McKelvey and Zavoina 1975):

$$y = a + \sum_{k=1}^k \beta_k x_k + \varepsilon$$

where  $y$  represents the dependent variable and  $J$  represents the type of dependent variable, expressed as  $1, 2, \dots, J$ . Therefore,  $y=1, y=2, \dots, y=J$ .  $x_k$  represents independent variables,  $K$  represents the sum of all variables,  $\beta_k$  represents the coefficient of  $x_k$ , and  $k=1, 2, \dots, K$ .  $\varepsilon$  represents the random term.

The Ordered Logit and Probit model has a regression format in which the dependent and unobservable variable  $y^*$  is a linear function of a group of independent variables  $x_i$  and random term  $\varepsilon$ .

$$y^* = a + \sum_{k=1}^k \beta_k x_k + \varepsilon$$

The discretization of the variable  $y$  is done using following equations:

$$\begin{aligned} y=0, & \text{ if } \mu_{-1} < y_i^* \leq \mu_0 \\ y=1, & \text{ if } \mu_0 < y_i^* \leq \mu_1 \\ y=2, & \text{ if } \mu_1 < y_i^* \leq \mu_2 \\ & \dots \\ y=J, & \text{ if } \mu_{j-1} < y_i^* \leq \mu_j \end{aligned}$$

where  $\beta_k$  and  $\mu$  are the parameters needed to be estimated by the model.  $\beta_k$  represents the weights of each independent variable and the importance of each in the dependent variable. The parameters  $\mu$  are the limits of defining the dependent variable  $y$ . The random term  $\varepsilon$  represents the error.

According to the relationship between  $y$  and  $y^*$ , the cumulative probability  $P(y \leq j)$  ( $j=1,2,\dots,J-1$ ) is expressed as:

$$\begin{aligned} P(y \leq j) &= P(y^* \leq \mu_j) = P(a + \sum_{k=1}^k \beta_k x_k + \varepsilon \leq \mu_j) \\ &= P[\varepsilon \leq \mu_j - (a + \sum_{k=1}^k \beta_k x_k)] \\ &= F[\mu_j - (a + \sum_{k=1}^k \beta_k x_k)] \\ &= F(\beta_{0j} - \sum_{k=1}^k \beta_k x_k) \end{aligned}$$

Where  $F$  expresses the cumulative distribution function of  $\varepsilon$ .  $\varepsilon$  is subordinated to logistic distribution, and the logistic function is:

$$\begin{aligned} g(x) &= \frac{1}{1 + e^{-x}}, F(\beta_{0j} - \sum_{k=1}^k \beta_k x_k) = \frac{1}{1 + e^{-(\beta_{0j} - \sum_{k=1}^k \beta_k x_k)}} \\ P(y \leq j) &= \frac{1}{1 + e^{-(\beta_{0j} - \sum_{k=1}^k \beta_k x_k)}} = \frac{e^{(\beta_{0j} - \sum_{k=1}^k \beta_k x_k)}}{1 + e^{(\beta_{0j} - \sum_{k=1}^k \beta_k x_k)}} \end{aligned}$$

where  $P$  represents the cumulative probability,  $y$  represents the dependent variable, and  $J$  represents the type of dependent variable, expressed as  $1,2,\dots,J$ . Therefore,  $y=1, y=2,\dots,y=J$ .  $x_k$  represents independent variables,  $K$  represents the sum of all variables,  $\beta_k$  represents the coefficient of  $x_k$ ,  $k=1,2,\dots,K$ .  $K$  represents the sum of all variables, and  $\beta_{0j}$  represents an intercept.

According to the change in a variable, the Ordered Logit and Probit model has been calibrated to quantify the change in choice willingness when improvements are made to the influential variables. The partial effects represent the probability of a specific result for  $y$ . The value of these effects could be either negative or positive depending on whether they represent a decrease or increase in probability of choosing each alternative for  $y$ . The partial effects are represented by  $\varepsilon_j(x_i)$ :

$$\delta_j(x_i) = \frac{\partial P(y = j)}{\partial x_i} = [f(\mu_{j-1} - \beta'x_i) - f(\mu_j - \beta'x_i)]\beta$$

The accumulated value of the partial effects of all the variables is also of interest:

$$\frac{\partial P(y = j)}{\partial x_i} \sum_{n=0}^i [f(\mu_{j-1} - \beta'x_i) - f(\mu_j - \beta'x_i)]\beta = -f(\mu_m - \beta'x_i)\beta$$

## Research Context

### Survey Analysis

The methodology presented in this paper was put into practice in Nanjing, Jiangsu Province, China. The city of Nanjing is the second-largest commercial center in the East China region after Shanghai and the transportation hub of eastern China. Nanjing also boasts an efficient network of public transportation, which consists mainly of bus, taxi, and metro systems. To help solve the inherent problems of public transportation, a public bicycle system was introduced into Nanjing in five districts. Currently, 560 public bicycle sites have been set up, which now have more than 16,000 bicycles.

The analysis in this study combines data from a questionnaire administered to commuters in the Metro stations of the Jiangning, Pukou, Hexi, and Gulou districts. The survey respondents, who were taking the subway, were recruited using a random approach, and the surveys were conducted from September to October 2014. A total of 800 survey forms were distributed, and 608 valid forms were returned. Forms were considered invalid if they were not properly completed or if many important questions were skipped. This survey's efficiency was approximately 76%.

The analysis of the data collected (Figure 2) shows that more males (52.6%) responded with valid surveys than females (47.4%). People who were ages 16–29 were the most prevalent responders (43.6%), followed by those ages 30–39 and 40–49, who accounted for 26.3% and 16.7%, respectively. The highest frequency of use of public bicycles was on work days (58.9%), followed by once a week (24.7%) and occasional use (4.1%). Regarding employment, people working as staff were shown to be the most prevalent respondents (50.1%), followed by the other categories (28.3%). People reporting that they cycled to transfer between other modes of public transport accounted for 59.8% of respondents; the next most prevalent purpose of travel was traveling to work, followed by entertainment.

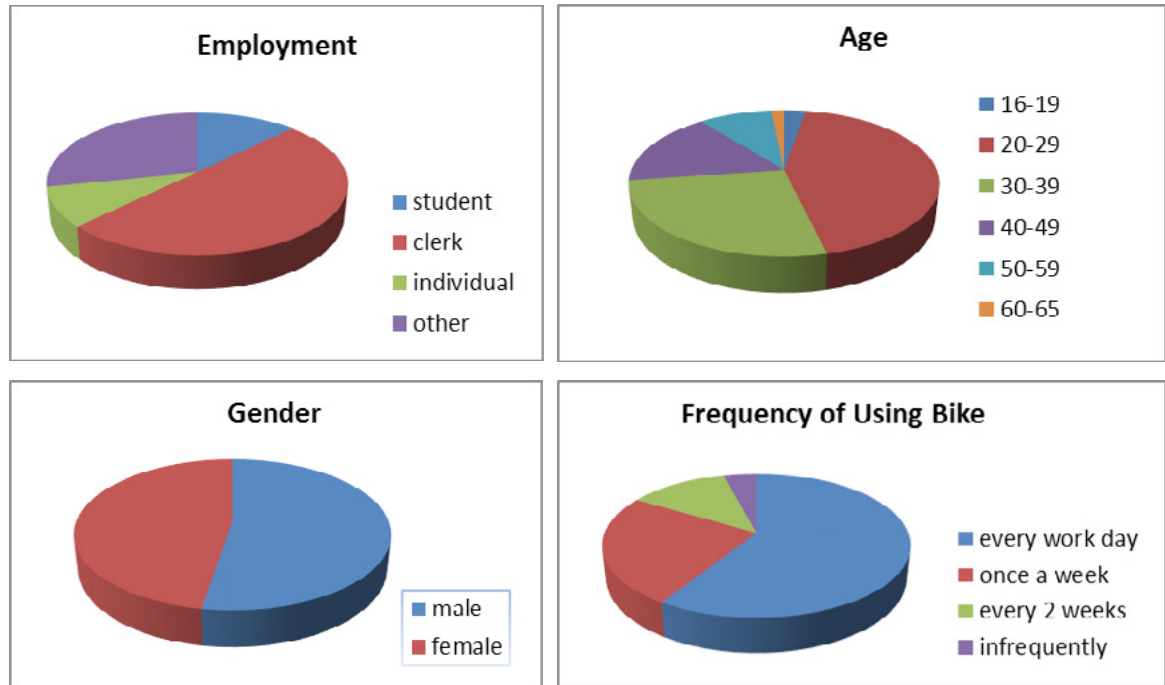


FIGURE 2. Proportions of valid sample of personal and usage characteristics

## Analysis of Willingness to Use a Public Bicycle System

### Preparation

After the initial analysis of the collected data, the next step was to analyze the willingness to use the public bicycle system by using the Ordered Logit and Probit model to define the dependent variable and independent variables. As described previously, dependent variable  $y$  represents the following options: 1 = “very willing,” 2 = “willing,” 3 = “unwilling,” or 4 = “very unwilling.” “Very willing” indicates that users would choose to use a public bike whatever the case. “Willing” expresses a preference for sometimes choosing to use a public bike. “Unwilling” indicates that users would not give priority to using a public bicycle, but in some cases may choose it. “Very unwilling” means that users would not use a public bicycle whatever the case.

Research by Ortuzar and Willumsen (2011) found that the use of the Ordered Logit and Probit model allowed interactions to be introduced which may, in many cases, explain user perceptions that might originate in socioeconomic factors or journey restrictions. In this paper, independent variables related to willingness to use a public bicycle system also include socioeconomic factors and journey restrictions. Socioeconomic factors included gender, age, employment, trip purpose, car ownership, and the frequency of public bicycle usage. Journey restrictions included load time at flat peak, load time at peak, length of time of bicycle use, rationality of public bicycle docking station location, and station facility level. Definitions for each variable are provided in Table 1.

**TABLE 1.**  
Independent Variable  
Definitions

Independent Variable	Definition
Gender	User gender
Age	User age (divided into 16–29, 30–39, 40–49, above 49)
Employment	Classified as students, staff, individual, or other
Trip purpose	Classified as work, entertainment, or transfer
Car ownership	Owning or not owning a private car
Frequency of public bicycle usage	Classified as every work day, once a week, once every two weeks, and infrequently
Load time at flat peak time	Length of time user needs to load bicycle, except at peak time, every day
Load time at peak time	Length of time user needs to load bicycle at 7:00–9:00am or 5:00–7:00 pm every day
Length of time of bicycle use	Length of time of bicycle usage
Rationality of public bicycle docking station location	Whether public bicycle docking station is convenient to user from home
Station facility level	Whether sufficient bicycles and bicycle parking spaces available

Gender, car ownership, station facility level, and rationality of public bicycle docking station location are two-dimensional variables: males are represented by 1, and females by 0; a good station facility level is represented by 1, and a poor station facility level by 0; owning a private car is represented by 1, and not owning a private car by 0; and a rational public bicycle station location is represented by 1, and an unreasonable location is represented by 0.

Age, employment, trip purpose, and the frequency of using public bicycles are categorical variables. Wang and Guo (2001) showed that the approach for coping with categorical variables is to create a dummy variable. In this paper, there are four categories for age: 16–29 is used as the reference category, and 30–39 (age1), 40–49 (age2), and more than 49 (age3) are the dummy variables. When a user's age is 16–29, age1 = age2 = age3 = 0; when a user's age is 30–39, then age1 = 1; otherwise, age1 = 0. For employment, staff is used as the reference category, and student, individual, and other are used as dummy variables. When the user is categorized as staff, job1 (student) = job2 (individual) = job3 (others) = 0. When the user is categorized as a student, job1 = 1; otherwise job1 = 0. To describe the frequency of using public bicycles, every work day is used as the reference category, and fr1, fr2 and fr3 are the dummy variables; when the frequency of using public bicycles is every work day, fr1 (once a week) = fr2 (a half month at a time) = fr3 (infrequently) = 0. To categorize travel purposes, transfer is used as the reference category, and work and entertainment are the dummy variables; when the purpose is categorized as transfer, aim1 (go to work) = aim2 (entertainment) = 0. Values and meanings for these are shown in Table 2.



**TABLE 2.**  
Measuring Dummy Variables

Virtual Variable	Meaning	Values
age1	age 30–39	if yes, age1=1; else age1=0
age2	age 40–49	if yes, age2=1; else age2=0
age3	age more than 49	if yes, age3=1; else age3=0
job1	student	if yes, job1=1; else job1=0
job2	individual worker	if yes, job2=1; else job2=0
job3	other	if yes, job3=1; else job3=0
fr1	once a week	if yes, fr1=1; else fr1=0
fr2	once every two weeks	if yes, fr2=1; else fr2=0
fr3	infrequently	if yes, fr3=1; else fr3=0
aim1	go to work	if yes, aim1=1; else aim1=0
aim2	entertainment	if yes, aim2=1; else aim2=0

With regard to the multi-class variables described above, in this paper, independent variables include gender, car ownership, load time at flat peak time, load time at peak time, length of time of bicycle use, rationality of public bicycle docking station location, station facility level, age1, age2, age3, fr1, fr2, fr3, job1, job2, job3, aim1, and aim2. Statistical analysis system (SAS) programming was used to analyze the data.

### **Procedure**

First, the correlation between willingness to use the public bicycle system and all independent variables was analyzed with the Ordered Logit and Probit model. As the research of Liu et al. (2008) showed that Wald testing could test the coefficient significance of the Ordered Logit and Probit model, Wald testing also was used.  $Wald\chi^2 > 3.841$  or  $P < 0.05$  of the coefficient of variables were found to be related to the dependent variables and were retained. SAS could output the value of  $Wald\chi^2$  and  $P$ . Then, variables that did not meet the  $Wald\chi^2 > 3.841$  or  $P < 0.05$  were deleted until the results of this method contained only variables that were associated significantly with willingness to use the public bicycle system.

Then, the relationship between influential independent variables and willingness to use the public bicycle system was analyzed. According to the change in an independent variable, the Ordered Logit and Probit model was calibrated to quantify the change in choice willingness when improvements were made to the influential variables. The percentage increase (positive sign) or decrease (negative sign) in the probability of each scale as a result of an improvement in the value of each independent variable was interpreted by the partial effects.

According to the Ordered Logit and Probit model and the rule of Wald testing, the results of data analysis are shown in Table 3.

**TABLE 3.**  
Results of Data Analysis Using  
Ordered Logit and Probit  
Model and Wald Testing

	Variables	Coefficient	Wald $\chi^2$	P values
	intercept 1	8.8359	33.9627	0.0001
	intercept 2	16.8977	57.6328	0.0001
	intercept 3	23.6258	65.8213	0.0001
	ltap	-0.3561*	9.9965	0.0001
	ut	-0.1393*	8.9617	0.0012
<b>Rationality of public bicycle docking station location</b>	yes (reference category)			
	no	-0.0838*	6.8911	0.0111
<b>Station facility level</b>	good	0.9677*	3.9613	0.0388
	no good (reference category)			
<b>Gender</b>	female	2.7344*	9.8727	0.0001
	male (reference category)			
<b>Employment</b>	staff (reference category)			
	job1	1.6321	1.1785	0.0993
	job2	-0.8974	0.1764	0.6353
	job3	-0.0731	0.0059	0.7132
<b>Car ownership</b>	yes (reference category)			
	no	0.9783*	4.6758	0.0255
<b>Proportional odds assumption</b>		P=0.6749, $\chi^2=31.1327$		
<b>Model<math>\chi^2</math>statistics</b>		P=0.0001, $\chi^2=450.449$		
<b>Aic, sc</b>		AIC=215.233, SC=260.613		
<b>Somers'd, gamma, Tau-a,c</b>		0.680,0.682, 0.519,0.842		

\* Significant at 0.05 confidence level

\*\* Significant at 0.1 confidence level

### Findings and Discussion

As the results of this research show, the seven most important factors that influence willingness to use the public bicycle system were identified and included load time at peak (ltap), length of time using bike (ut), rationality of public bicycle docking station location (ra), station facility level (el), gender (female), car ownership (not owning a private car), and employment (job1). These factors incorporate both socioeconomic characteristics and journey constraints. Increasing willingness to use the public bicycle system should focus on these seven key factors, as discussed below.

As shown previously with regard to the Ordered Logit and Probit model,  $\beta_k$  represents the the weights of each independent variable and the importance of each to the dependent variable. Table 2 showed the coefficient magnitudes of these variables, and the significance is greatest to least as follows: gender (female), job1 (student), car

ownership (not owning a private car), el (station facility level), ut (length of time of bicycle use), itap (load time at peak), and ra (rationality of public bicycle docking station location). Gender (female), job1 (student), and car ownership (not owning a private car) are socioeconomic factors, and the coefficient magnitudes of these variables were found to be the greatest in this research. The following journey restrictions were shown to be less important and to have relatively less impact on willingness to use the public bicycle system: station facility level (el), length of time of bicycle use (ut), load time at peak (itap), and rationality of public bicycle docking station location (ra). Therefore, socioeconomic factors have a more relevant impact on willingness to use the public bicycle system than journey restrictions. These results are discussed in more detail below.

As seen in Table 3, the sign is positive for the following partial effects: gender (female), car ownership (not owning a private car), job1 (student), and station facility level (el). This indicates that an improvement of 1 in the value scale of these variables causes an increase in the probability to score willingness to use the public bicycle system as “very willing.” The variable with greatest impact on increased probability of getting the best evaluation (“very willing”) of willingness is gender (female). The partial effects corresponding to this variable quantify an increase of 12.75% in the probability of scoring “very willing.” The job1 (student) variable will have a 9.51% impact on the increased probability of users indicating “very willing.” Similarly, an improvement of 1 in valuation scale of car ownership (not owning a private car) causes an increase of 7.05% in the probability of a score of “very willing.” An improvement of 1 in the valuation scale of station facility level (el) causes an increase of 4.99% in the probability of a score of “very willing.” These findings also indicate that female or students users will be more likely to choose the public bicycle system when all other conditions are the same. Additionally, users who have no private car will tend to use the public bicycle system more than those who have a private car. If the station facility level is better, then willingness is likely to be greater.

In contrast, an improvement of 1 in the valuation scale of the the following partial effects with a negative sign will result in decreases in the probability of a score of “very willing:” load time at peak time (itap) (5.55% decrease), length of time of bicycle use (ut) (3.2% decrease), and rationality of public bicycle docking location (ra) (7.32% decrease). These results show that if itap and ut are increased, user willingness to use the public bicycle system (“very willing”) may be reduced. If ra is less reasonable and more inconvenient, users will be less likely to be “very willing” to select the public bicycle for their commute, as they do not wish to spend more time using a bicycle and transferring to other transportation modes. Therefore, it is essential to reduce the load time at the peak time and the length of time using a public bicycle and to optimize the location of the public bicycle docking station to increase the usage rate of public bicycles.

## Conclusions and Recommendations

Public bicycles play a vital role in sustainable transportation development. By adopting a discrete choice model (Ordered Logit and Probit model), this paper contributes to research on willingness to use a public bicycle system, including a study of the relative

importance of influential variables on choice willingness. Specifically investigated were the effects on user choice willingness of an implemented public bicycle system in Nanjing.

First, this research identified seven factors that influence willingness to use Nanjing's public bicycle system: load time at peak time, length of time using bicycle, rationality of public bicycle docking station location, station facility level, gender, car ownership, and employment. Therefore, any strategy to increasing willingness to use the public bicycle system should consider these variables.

Second, this research included an analysis of the relevance of influential variables in willingness to use the public bicycle system. Socioeconomic factors were shown to have a more important impact on willingness than journey restrictions. This finding indicates that subjectivity of the user is shown to be relatively strong for choosing the public bicycle.

Finally, according to the partial effects results, it was found that an improvement of 1 in the valuation scales for length of time of bicycle use ( $ut$ ), load time at peak ( $itap$ ), and rationality of public bicycle docking station location ( $ra$ ) will cause a decrease in the probability of a user indicating that he is "very willing" to use the public bicycle system. Load time at peak is related to the number of bicycles in the public bicycle docking station. If a station does not have sufficient bicycles to provide to users, the users will not be able to borrow the bicycles at the peak and instead must wait for bicycles that could be redistributed from another station. This increases the load time at peak, which reduces the score to "very willing." Similarly, if the length of time using a public bicycle is increased, users being "very willing" may be reduced. This may be a direct result of the locations of public bicycle docking stations being less reasonable and more inconvenient for users.

Based on these findings, the following recommendations for public bicycle development are made. The government should (1) build reasonably-located public bicycle docking stations and (2) design more reasonable redistribution of public bicycles so that sufficient bicycles are provided for users, thereby reducing the loading time at peak. Both of these approaches could encourage more people (including private cars owners) to use the public bicycle system, and as a result, reduce the total number of vehicles on Nanjing's roads.

This research had some limitations. More stratifying socioeconomic variables (such as educational background, income level, etc.) were not taken into account; these data could be obtained through additional investigation in future studies. Further research also should compare the social, economic, and ecological effects of conversion to a public bicycle system with other transportation modes so people could choose to use public bicycles based on consideration of their social benefits, reduction in urban traffic congestion, and ability to solve the urban traffic "last mile" problem.

## Acknowledgments

This research was sponsored by the National Basic Research Program of China (973 Program) (No. 2012CB725402), research on key technologies of multimodal public transportation in China, and by the National Natural Science Foundation of China (No.61573098), research on the carrying capacity and scheduling models of urban flex-route transit systems.

## References

- Bachand-Marleau, J., B. H. Y. Lee, and A. M. El-Geneidy. 2012. "Better Understanding of Factors Influencing Likelihood of Using Shared Bicycle Systems and Frequency of Use." *Transportation Research Record*, 2314: 66-71.
- Debrezion, G., E. Pels, and P. Rietveld. 2009. "Modelling the Joint Access Mode and Railway Station Choice." *Transportation Research Part E: Logistics and Transportation Review*, 45(1): 270-283.
- dell'Olio, L., A. Ibeas, and P. Cecin. 2010. "Modeling User Perception of Bus Transit Quality." *Transport Policy*, 17(6): 388-397.
- DeMaio, P. 2009. "Bike-sharing: History, Impacts, Models of Provision, and Future." *Journal of Public Transportation*, 12(4).
- Givoni, M., and P. Rietveld. 2007. "The Access Journey to the Railway Station and Its Role in Passengers' Satisfaction with Rail Travel." *Transport Policy*, 14(5): 357-365.
- Hensher, D. A., C. Mulley, and N. Yahya. 2009. "Passenger Experience with Quality-Enhanced Bus Service Level Constraints: The Tyne and Wear 'Superoute' Service." *Transportation*, 37(2): 239-256.
- Liu, M., L. Yu., and Z. Zhang. 2008. "Cumulative Logistic Regression Based Measurement Models Road Traffic Congestion Intensity." *Journal of Beijing Jiaotong University*, 32(6).
- Mckelvey, R., and W. Zavoina. 1975. "A Statistical Model for the Analysis of Ordinal Level Dependent Variables." *Journal of Mathematical Sociology*, 4, 1975, 103-120.
- Nanjing Institute of City and Transport Planning (NICTP). 2013. "Annual Report of Nanjing Transport." Nanjing: Nanjing Institute of City and Transport Planning.
- National Bureau of Statistics of China. 2013. *Statistic Yearbook of China*. Available at <http://www.stats.gov.cn>.
- Ortuzar, J. D., and L. G. Willumsen. 2011. *Modeling Transport*, 4<sup>th</sup> edition. Hoboken, N.J.: John Wiley and Sons.
- Rainer-Harbach, M., P. Papazek, B. Hu, et al. EvoCOP, LNCS 7823, 2013:121-132.
- Raviv, T., M. Taur, and I. A. Forma. 2013. "Static Repositioning in a Bike-Sharing System: Models and Solution Approaches." *European Journal of Transport Logistics.*, 2(3): 187-229.

Shaheen, S., H. Zhang, E. Martin, and S. Guzman. 2010. "Bikesharing in Europe, the Americas, and Asia." *Transportation Research Record*, 2143: 159-167.

State Council. 2012. State Council's Guidance on the Priority Development of Urban Transit. Available at [http://www.gov.cn/zwgk/2013-01/05/content\\_2304962.htm](http://www.gov.cn/zwgk/2013-01/05/content_2304962.htm).

Wang, J., and Z. Guo. 2001. *Logistic Regression Model—Methods and Application*. Beijing: Higher Education Press: 237-239.

## About the Authors

**PEIYU FENG** ([fpv\\_131@sina.com](mailto:fpv_131@sina.com)) is with the School of Transportation at Southeast University, China.

**WENQUAN LI** ([wenqli@seu.edu.cn](mailto:wenqli@seu.edu.cn)) is a Professor at the School of Transportation at Southeast University. He holds a Ph.D. from the School of Transportation at Southwest Jiaotong University, and his research interests include transportation planning and management, traffic flow theory, traffic safety, and public transit.



---

# The Effects of Access and Accessibility on Public Transport Users' Attitudes

Subeh Chowdhury, Kasey Zhai, and Asif Khan  
University of Auckland, New Zealand

---

## Abstract

*This study investigates existing users' attitudes towards public transport from two perspectives. First, the effects of accessibility to various destinations and ease of access to terminals on public transport users' attitudes are determined. Second, the contribution of social norm, as an information source, in the formation of users' attitudes is assessed. A user-preference survey was undertaken in Auckland, New Zealand, at two terminals. Data were analyzed using ordinal and logistic regression models. Findings showed that residential density and quality of the built environment, particularly safety, have an effect on the number of pedestrians who access a terminal. Accessibility to various destinations, "reaching work/education," and "reaching other suburbs" in both data sets were statistically significant for existing users' satisfaction with the current system. The findings also show that negative experiences of others have an adverse effect on existing users' intentions to continue ridership. Overall, the results showed that to retain existing patronage, the ease of access to terminals and connectivity to various destinations need to be of a high standard.*

**Keywords:** Public transport, attitude, access, walking

## Introduction and Research Objectives

Achieving user-friendly public transport (PT) systems has become an increasingly crucial goal for urban transport planning due to road transport contributing significantly towards climate change (Uherek et al. 2010). Emissions of CO<sub>2</sub> from the road transport sector are in an upward trend (Black and Sato 2007); private vehicles have been identified as a main contributor to greenhouse gas (GHG) emissions (Chapman 2007). In addition to air pollution, other issues such as noise pollution and traffic congestion also have been linked with travelers' heavy reliance on private vehicles. Delays caused by congestion have been estimated to cost businesses billions every year (Brog et al. 2009). A key climate change mitigation strategy recommended by the Intergovernmental Panel on Climate Change (IPCC) is to create modal shift from private vehicles to PT (Stanton et al. 2013). As such, globally, government agencies are adapting their regional transportation

planning process to prioritize and encourage the development and use of PT (Handy 2008). With trip making behavior growing in complexity in terms of purpose and spatial destinations, operators and planners continue to face the challenge of providing travelers with an attractive system (Hensher and Reyes 2000; Chowdhury et al. 2015).

Access to and the accessibility of PT systems has always been focal service issues. The other issue that effects PT use is the attractiveness of private vehicles. Private vehicle use has been preferred to PT not only for its instrumental functions (freedom, comfort, and convenience) but also for its symbolic (status in society) and affective (driving is perceived as being pleasurable) functions (Hiscock et al. 2002; Beirao and Sarsfield-Cabral 2007). Therefore, the loyalty of existing PT users to continue ridership is uncertain. Mavoa et al. (2012) states that there is a relatively small number of research on accessibility using PT. To the authors' knowledge, there exists a gap in the literature on how accessibility of a PT network influences existing users' attitudes and thereby retains loyalty. Literature analyzing the general attitude of travelers towards PT use has shown that although improvement in service quality is likely to increase ridership, the level of increase can be limited if travelers hold prejudices towards the image of PT (Murray et al. 2010). Such studies have identified the importance of attitude in travelers' willingness to use PT. Attitude is defined as an individual's positive or negative evaluation of performing an intended action (Ajzen 2005). In addition to attitude, it has been found that travelers' intentions to select PT is influenced by social norm (Bamberg et al., 2007). Social norm is defined by Ajzen (2005) to be a reflection of an individual's perceptions of the social pressures that are in place to perform or not perform a certain action. Karash et al. (2008) discussed that social norm can act as an easily accessible and comprehensible information source for outcome formation. Klockner and Matthies (2004) discussed that internalized social norms can assist in the shaping of attitude towards a particular action.

The present study investigates existing users' attitudes towards PT from two perspectives. First, the effects of accessibility to destinations and ease of access to terminals on existing users' attitudes is determined. A terminal is defined as a hub, station, or transfer point. Second, the contribution of social norm, as an information source, in the formation of users' attitudes towards PT is assessed. Selected elements of the built environment surrounding terminals and network connectivity were used to measure access and accessibility, respectively. A user-preference survey was conducted in Auckland, New Zealand. A travel survey conducted by the Ministry of Transport (2014) between 2010 and 2013 indicated that in terms of modal share, PT has a 2.8% share in New Zealand. The findings of this study are expected to assist planners and operators in attracting and retaining patronage. The next section provides a review of literature and is followed by discussion of the hypothesis. A description of the survey implementation, results and discussion, and conclusions complete the paper.

## **Literature Review**

This section provides a literature review that discusses the importance of accessibility to various destinations through network coverage and ease of access to terminals in encouraging travelers to use PT.

### **Accessibility**

One of the key measures of accessibility is providing access to different activities/opportunities (Mavoa et al. 2012). The other measure is time-based (walking time to stop and journey time). Accessibility can be determined by the network coverage of a PT system and access by active modes (walking and cycling) to different land uses. Bertolini et al. (2005) stated that integration of land use planning and transport is a critical component in achieving sustainable development. The study emphasized the shift of focus from planning for mobility to planning for accessibility to access sustainable travel options more effectively. Manaugh and El-Geneidy (2012) discussed that high accessibility at a regional level leads to more sustainable travel outcomes such as shorter travel distances, which produced shorter journey times. Land use mixture also has been shown to influence travel behavior. Manaugh and Kreider (2013) discussed that it is not the proportion of various land uses that is important; rather, it is the level of interaction among land uses. Fine-grained mixing of complementary land uses creates opportunities for walking, cycling, and use of PT to reach desired destinations. Residents of mixed-use urban areas were seen to make shorter journeys. Zhang et al. (2012) also suggested that compact, mixed-use developments are effective in reducing vehicles miles traveled (VMT) per person through shorter journeys.

### **Access to Public-Transport Terminals**

A critical factor in PT use is the access time or distance of a terminal/stop (Murray 2001). Saelens and Handy (2008) discussed that the ease of access is influenced by factors such as the aesthetic quality and attractiveness of the environment, infrastructure provision, and street connectivity. Walkable environments most often are defined by the presence of appropriate physical elements of the built environment. This includes high-quality visual amenity and architectural design, pedestrian supporting infrastructure, and street connectivity and permeability (Bently et al. 1985; Speck 2012). Speck (2012) explains that environments must first provide the appropriate conditions to encourage walking and PT use. In addition to an efficient PT network, such environments need to ensure personal safety and be comfortable, interesting, and stimulating. Saelens and Handy (2008) found that greater street connectivity can provide a higher variety of route choices that ensure that journeys remain interesting. Neighborhoods with a permeable and integrated road network can offer more direct route choices for both pedestrians and services, thereby increasing the appeal of PT. The aesthetic quality and attractiveness of an environment often are determined by the façade of buildings. Varied visual architecture and public frontages that line streets with activities are more likely to create neighborhoods that feel secure, comfortable, and interesting. Borjesson (2012) states that a key factor for perceived and actual personal safety when accessing terminals/stops is the design of the built environment. Features such as footpaths with clear sight distance and public spaces contribute to pedestrians feeling secure.

### **Definition of Attitude and Social Norm**

Studies by Carrus et al. (2008) and Eriksson and Forward (2011) confirmed that both attitude and social norm can accurately predict travel behavior. Banaji and Heiphetz (2010) stated that attitude is "a psychological tendency that is expressed by evaluating a particular entity with some degree of favour or disfavour." Attitude is determined by the

beliefs about the consequences of a behavior (Ajzen 1991). It is underlined by behavioral beliefs, which are determined by an individual's evaluation of all possible outcomes associated with conducting an action. The outcomes are identified using existing and accessible information. Whether an individual has a positive or negative attitude towards PT will depend on whether positive or negative evaluations are associated with its use. Furthermore, according to Klockner and Matthies (2004), attitude is shaped partly by personal norms, which are described to be internalized social norms. Social norm is defined as the individual's perception of social obligation and important referents' expectation to perform or not perform the intended action (Kallgren et al. 2000). This norm is underlined by normative beliefs that are an individual's belief of referents' expectation for performance or non-performance of the behavior. Normative beliefs also are determined by an individual's motivation to comply and the fear of social sanctions (Bamberg et al. 2007). An individual is more likely to perform an action when normative beliefs indicate that there is social pressure and expectation to do so or when there is a stigma attached to alternative actions or inaction.

### Assumptions

Terminals that are both surrounded by and appropriately connected to residential dwellings and commercial uses provide greater accessibility as well as a range of destination choices for travelers entering and egressing. The design of the built environment can lead to the characterization of neighborhoods as being "walkable" or "PT-oriented" (Stewart and Moudon 2014). Connective street layouts can reduce journey time and increase destination choice and PT accessibility (Bently et al. 1985). The appearance and design features of the public streetscape such as building façades and pedestrian infrastructure contribute to create safe, interesting, and comfortable walking environments for travelers when accessing PT (Borjesson 2012; Speck 2012). According to this point of view, the first assumption (A1) is proposed. Murray (2003) states that it is relatively straightforward to determine service access provided spatial information exists to examine the proximity from locations of interest to PT terminals. As the present study is in regards to perceived accessibility, the existing users' attitudes towards PT use was measured by determining the ease of accessibility to various destinations through network coverage and ease of access to terminals.

*A1: Accessibility to different land uses by the public transport system and ease of access to terminals has an effect on existing users' attitudes towards public transport.*

Studies (Bamberg et al. 2007; Karash et al. 2008) confirm that social norms have a lesser influence on intention than attitude. Bamberg et al. (2007) explains that social norms influence behavior through an individual's fear of social sanctions. Although social norms are found to have a weak influence on intention, they can act as an easily-accessible and comprehensible information source for outcome evaluation. Accordingly, the second assumption (A2) is whether the views of others towards PT serve as an information source for the formation of users' attitudes. This was measured by assessing the relevance of the views, actions, or previous experiences of important referents on users' attitudes and, thereby, their intention to continue ridership.

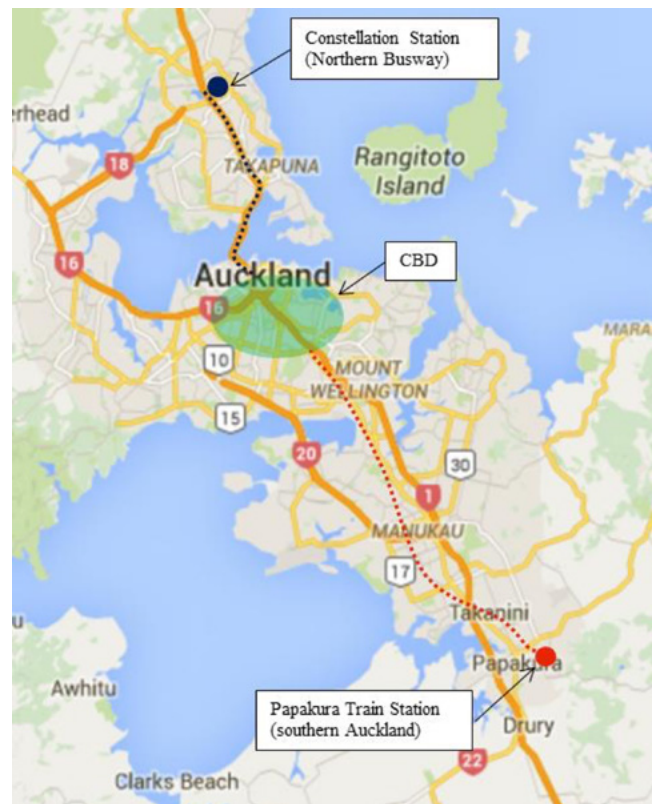
A2: Social norms are used as an information source in the formation of existing public transport users' attitudes.

## Survey Design

### Survey Locations

The survey locations chosen for this study were Constellation Station (L1) and Papakura Transport Centre (L2) in Auckland, New Zealand. The locations were selected due to differences between the network coverage from the terminals and the ease of access to the terminals. L1 is located approximately 15 kilometers north of Auckland's central business district (CBD) and is one of the five stations in Auckland's bus rapid transit, the Northern Busway. Local feeder routes are connected to the station, thus allowing greater destination choices. As such, PT users are able to use a number of bus services that are directly connected to the city center and neighboring suburbs. A study by Ceder et al. (2009) on the connectivity of the Northern Busway showed that the routes of the busway have greater connectivity compared to alternative routes within Auckland. L2 is located approximately 35 kilometers south of Auckland's CBD, from which users have access to both bus and train services that focus on providing a link between the Papakura suburb and the CBD. The bus service has no priority provisions. Both locations provide park-and-ride facilities free of charge, with 370 spaces in L1 and 230 in L2 (Auckland Transport 2015). Site visits indicated that parking spaces are fully utilized within the morning peak period. Figure 1 shows the geographical location of the two terminals.

**FIGURE 1.**  
Geographic locations of terminals

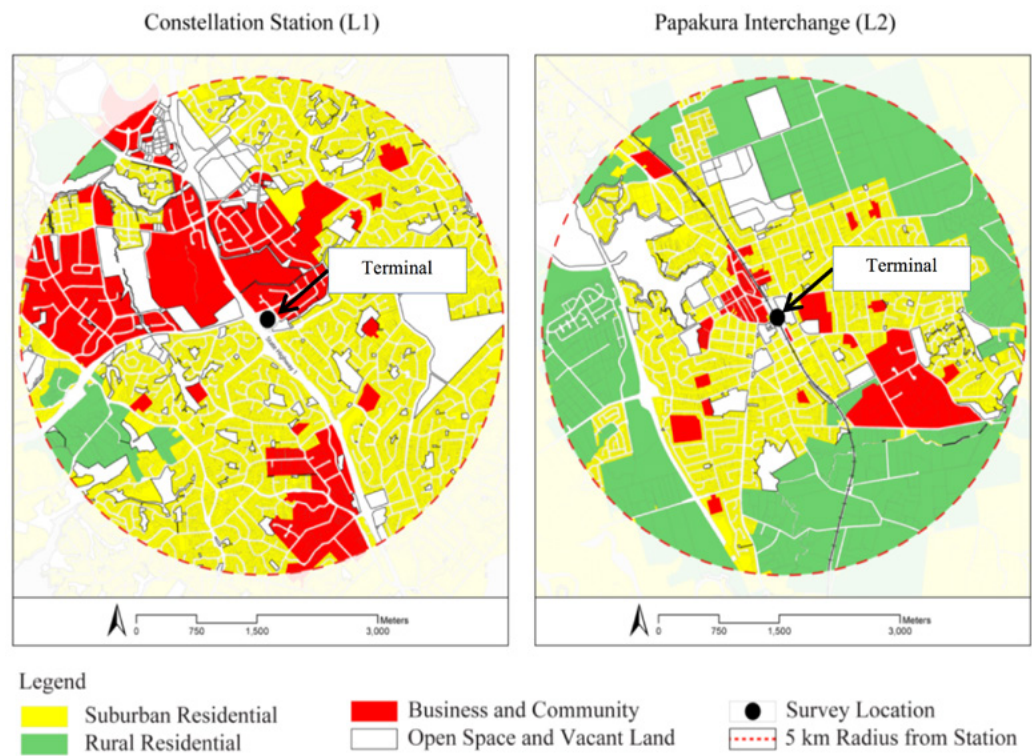


Adapted from Google Maps



Within a five-kilometer radius, L1 is adjacent to and surrounded by a diverse range of commercial facilities, including a major shopping mall. Such facilities are directly accessible through existing PT services that closely link the terminal to neighboring stations. L2 is an isolated terminal located south of Auckland city. Within a five-kilometer radius, L2 is surrounded by suburban neighborhoods that drastically transition into rural property lots of a lower residential density (Auckland Council 1999). The closest major shopping mall is located approximately 13 kilometers north and is accessible by PT services. Figure 2 illustrates the different surrounding residential density and land uses of the two locations, and Figure 3 demonstrates the locality of the two terminals. Due to the differences in the surrounding residential densities of L1 and L2, L1 can be accessed by a greater number of residents.

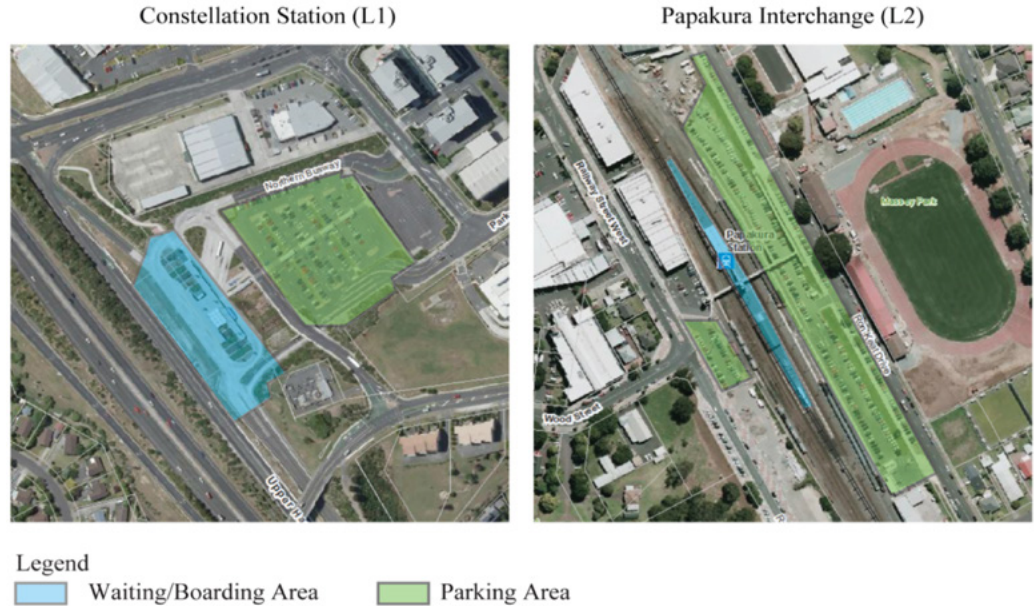
**FIGURE 2.**  
L1 and L2 surrounding  
land use



Source: Auckland Council District Plan (1999)



**FIGURE 3.**  
Locations of L1 and L2



Adapted from Google Maps

Note: A neutral point ("no opinion") was included in the scale to acquire responses for all items in the questionnaire and to retain the interest of participants (Crano and Brewer 2002; Singleton and Straits 2005).

In terms of the street network design, L1 is located adjacent to a major highway and is surrounded by a network of cul-de-sacs that form irregularly-shaped urban blocks. These factors decrease permeability and compromise access to the terminal from the southwestern side, particularly for pedestrians. L2 is surrounded by a grid-like network in which urban blocks range between 90 and 400 meters, leading to varying degrees of permeability and comparatively easier access by walking within the immediate proximity of the terminal. Site visits indicated that L1 and its surroundings have better lighting than L2 for night journeys. Both terminals are surrounded by commercial and residential uses, which create active street frontages that increase feelings of surveillance and personal safety.

### Questionnaire

The questionnaire was designed to be completed within five minutes while PT users were waiting for their vehicle to arrive. For this reason, socio-demographic and trip characteristics question were limited to gender, age, and frequency of PT use. Table 1 provides the measurement items included in the questionnaire, categorized according to the themes. An option "Please tick if not applicable" was provided to participants. A 5-point Likert Scale (strongly agree to strongly disagree) was used as the response scale and was designed to measure one specific perception of the item presented to the respondent (May 2011). The Likert Scale represents one of the most adopted approaches for generating reliable scales of individual differences (Crano and Brewer 2002; Singleton and Straits 2005) and has been commonly used in travel behavior studies (Heath and Gifford 2002; Bamberg et al. 2007; Gatersleben and Uzzell 2007; Carrus et al. 2008).

**TABLE 1.**  
Measurement Items in  
Questionnaire

Category	Description	Code or Unit*
Attitude and Intention	I am satisfied with the PT system.	1
	Do you intend to continue using PT within the next 6 months?	2
Access to Terminals (L1 and L2)	The ideal time taken to access PT by walking.	3
	The ideal time taken to access PT by driving.	3
	When walking between home and station, I feel safe at all times of the day.	1
	When walking between home and station, I feel safe from vehicular traffic.	1
	When walking between home and station, I feel there are comfortable footpaths.	1
Accessibility of Destinations (Network Coverage)	I can use PT to reach recreational activities with ease.	1
	I can use PT to reach work and/or education with ease.	1
	I can use PT to run errands with ease (supermarket, post office, medical clinic, etc.).	1
	I can use PT to reach other suburbs within Auckland with ease.	1
Social Norms as Information Source	I take PT because someone whose opinion I value believes that I should.	1
	My choice to take PT is influenced by someone close to me doing the same (family/friend/colleague).	1
	I will not use PT in a given situation if someone I know had a bad experience with the same service.	1

\* Code/Unit 1: 1 = Strongly Agree, 2 = Agree, 3 = Neutral, 4 = Disagree, 5 = Strongly Disagree

\*\* Code/Unit 2: Yes/No

\*\*\*Code/Unit 3: 1 = 0–5 minutes, 2 = 6–10 minutes, 3 = 11–15 minutes

### Limitations of Survey

This study required a sample of existing PT users. It was not possible to obtain a sampling frame of PT users; however, an effort was made to select the participants randomly. Sample selection bias was mitigated by selecting every third PT user entering the stations. It is to be noted that the sample represents a random sample of only existing PT users who were undertaking their morning commute at the two survey locations. A pilot survey included both the morning (7:00–9:00 AM) and evening (4:00–6:00 PM) peak periods. In the pilot survey, the response rate in the evening peak was less than 10% and in the morning peak it was around 80% at both L1 and L2. This is due to the limited number of users willing to participate in the evening peak period. After being briefly informed of the research purpose, commuters were invited to participate and complete the self-administered questionnaire.

## Results and Discussion

### Data Summary

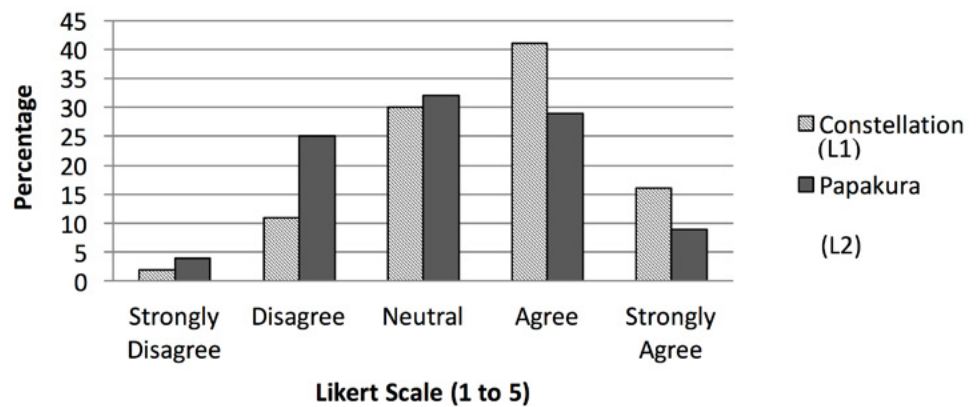
A total of 356 questionnaires were distributed among the two survey locations, of which 300 were completed and deemed suitable for analysis. Both locations received a high response rate of approximately 90%. Questionnaires deemed unsuitable for analysis were due to incompleteness, of which 48 of the 56 originated in L1 and 8 in L2. This was due to higher service frequencies and shorter waiting times at L1, providing participants with less time for completion.

The completed questionnaires comprised 160 from L1 and 140 from L2. The most common trip destination for commuters from both locations was the CBD, contributing to 48% of trips from L1 and 43% of trips from L2. Within L2, 92% of the trips originated from the Papakura suburb, and the remaining 8% were from neighboring adjacent suburbs. The station does not serve as a frequent transfer point, as all journeys originated from the station. At L1, 84% of the trips originated from the station, with residents from the Constellation suburb and neighboring adjacent suburbs. The remaining 16% were from other suburbs within Auckland City, for which the station was used as a transfer point. A summary of the participants' socio-demographic characteristics and trip frequency at each location is shown in Table 2. Figure 4 illustrates that the most common response category to the measurement item "I am satisfied with the public transport system" was "Agree" (41%) in L1 and "Neutral" (32%) in L2. Overall, participants showed greater satisfaction in L1; 57% of participants selected "Agree" and "Strongly Agree" compared to 38% of the participants in L2.

**TABLE 2.**  
Data Sets

		L1 Data Set	L2 Data Set
Gender	Male	49%	42%
	Female	48%	56%
Age	18–30	62%	43%
	31–50	30%	41%
	51–65	6%	14%
	65+	2%	1%
Frequent PT users		84%	87%
N (sample size)		160	140

**FIGURE 4.**  
Commuter satisfaction with services at survey locations



### Regression Analysis

#### Regression Model for A1

Ordinal regression was performed using the data set from each location to assess the first assumption. This approach was used as it is suitable for the small sample size. The dependent variable, attitude, was measured through participants' satisfaction with the existing PT system. The response scale of the variables were a five-point Likert Scale (1 =

Strongly Agree, 5 = Strongly Disagree). The statistically significant independent variables ( $p \leq 0.05$ ) for each location are shown in Tables 3 and 4. The measures of model fit (chi-square, goodness of fit, parallelism, and  $R^2$ ) indicate that the proposed models are a suitable fit for the L1 and the L2 data set (Kleinbaum and Klein 2010). In both data sets, the socio-demographic characteristics were not statistically significant in the models. A chi-squared test showed that the association of age to the locations is statistically significant. As indicated in Table 2, 62% of the participants in L1 are within the age bracket of 18–30 compared to 43% in L2.

**TABLE 3.**  
Statistically Significant H1  
Predictor Variables for L1

A1 Predictor Variables for Constellation Data Set	Reference Category	Response Category	Estimate	Odds Ratio	P-value
Ideal time taken to access PT through walking.	10–15 minutes	0–5 minutes	-1.322	0.27	0.018*
I can use public transport to reach work/ education with ease.	Strongly disagree	Strongly agree	-4.309	0.013	0.000***
		Agree	-3.947	0.019	0.000***
		Neutral	-2.746	0.064	0.013*
I can use public transport to reach other suburbs within Auckland with ease.	Strongly disagree	Strongly agree	-1.579	0.21	0.027*
Model fit	Chi-square = 0.000 < 0.05 Goodness of fit = 0.904 > 0.05 Parallelism = 0.263 > 0.05 $R^2 = 0.42$				

Note:  $p\text{-value} < 0.05^*$ ,  $p\text{-value} < 0.01^{**}$ ,  $p\text{-value} < 0.001^{***}$

**TABLE 4.**  
Statistically Significant H1  
Predictor Variables for L2

A1 Predictor Variables for Papakura Data Set	Reference Category	Response Category	Estimate	Odds Ratio	P-value
Ideal driving time to a bus stop or station.	10–15 minutes	0–5 minutes	-1.414	0.24	0.006**
I can use public transport to reach work/ education with ease.	Strongly disagree	Strongly agree	-2.080	0.12	0.019*
		Neutral	-1.916	0.15	0.043*
I can use public transport to reach other suburbs within Auckland with ease.	Strongly disagree	Neutral	-1.857	0.16	0.005**
Model fit	Chi-square = 0.000 < 0.05 Goodness of fit = 0.999 > 0.05 Parallelism = 0.215 > 0.05 $R^2 = 0.36$				

Note:  $p\text{-value} < 0.05^*$ ,  $p\text{-value} < 0.01^{**}$ ,  $p\text{-value} < 0.001^{***}$

Within the L1 dataset, the variables “ideal walking time” ( $p\text{-value} = 0.018$ ), “reaching work/education” ( $p\text{-value} = 0.000$ ), and “reaching other suburbs” ( $p\text{-value} = 0.027$ ) were the statistically significant predictors of users’ satisfaction. In other words, a lower Likert Scale rating of “Strongly Agree” or “Agree” was more likely to be selected by a participant in agreement with the measurement item for “reaching work/education” and “reaching other suburbs.” This is represented by the negative value of the estimates.

One explanation for this result is that PT services within L1 are well-connected to the CBD and adjacent suburbs. It also was found that the time desired by users to access a terminal is less than five minutes by walking (p-value = 0.018, estimate = -1.322). The predictor variables "ideal driving time" (p-value = 0.006), "reaching work/education" (p-value = 0.019), and "reaching other suburbs" (p-value = 0.005) were statistically significant for users' satisfaction within the L2 dataset. Users were more likely to be satisfied when terminals can be accessed within five minutes by driving. Similar to L1, results of the regression model show that a low Likert Scale rating for satisfaction was associated with agreement to "reach work/education" and "reaching other suburbs" measurement items.

A1 results indicate the importance of addressing the issues related to the ease of access to terminals and accessibility to various destinations using PT as a travel mode in existing users' attitude. Results at both locations show that perceived ease of access to terminals has a statistically significant influence upon existing users' satisfaction with PT. Within the L1 dataset, walking time to access the terminal was statistically significant, whereas within the L2 dataset, driving time was statistically significant. Furthermore, it was found within the L1 dataset that 62% of participants walked to access PT compared to 34% within the L2 dataset. Such results may be explained by L1's surrounding built environment being more pedestrian-oriented than L2 in relation to safety and surveillance from a higher proportion of business and commercial land use. Another explanation is the high proportion of participants being under 30; young commuters are more likely to walk.

In terms of accessibility to various destinations using PT, in both data sets, "reaching work/education" and "reaching other suburbs" were statistically significant for existing users' satisfaction with the current PT system, and the ability to undertake errands or reach recreational activities were found to be statistically insignificant. This is a sensible result, as it reflects the activities that are suitable for PT. Trips for errands involve additional possessions such as luggage (e.g., shopping bags), which makes it physically difficult to use PT. Similarly, recreational trips are likely to involve strollers or bikes, which create constraints in using PT. Furthermore, it was found within both data sets that items measuring the presence of safe, comfortable, and interesting walking environments were not statistically significant predictors of attitude. An explanation for this result is that both L1 and L2 provide good quality built environments. As such, these items were not deciding factors in their choice to use PT.

Overall, results from regression models have shown that existing users from L1 exhibit positive attitudes towards PT. This may be attributed to the greater accessibility provided by the Northern Busway. For instance, work and education centred within the CBD can be reached by commuters from L1 within a shorter journey time than L2. This is due to both the geographic location and the provision of supporting infrastructure. The Northern Busway has a dedicated bus lane, which allows services to bypass congestion during morning and evening peak periods, increasing the performance of the service for commuter with trips originating from L1. PT services from L1 also connect to adjacent suburbs. The neutral response within L2 indicates a certain amount of dissatisfaction towards the PT service. Reaching work and education



within the CBD and other northbound suburbs is most likely the most predominant use of services from the terminal. Service performance may be limited by the station's isolated geographic location and limited accessibility to adjacent suburbs.

Along with the geographic location, the results also reflect the difference in the socio-demographic characteristics of the users. The frequency of services in L2 is less than L1, and time is a more critical factor for working commuters than students. The lower satisfaction of L2 can be associated with the higher percentage of commuters age  $\geq 30$  and lower percentage for those ages 18–30. L2 has a higher proportion of female participants (56%); females in a household are more likely to undertake trips for errands and, as such, the reduced accessibility offered by L2 is reflected in the results for satisfaction.

### Regression Model for A2

A logistic regression model was undertaken to validate A2. The dependent variable, participants' intention to use PT, was measured on a dichotomous response scale. The three independent variables are given in Tables 5 and 6 along with the results for L1 and L2, respectively. The Hosmer–Lemeshow test is a goodness-of-fit statistic used to determine whether the developed model reasonably approximates the data (Kleinbaum and Klein 2010).

**TABLE 5.**  
A2 Predictor Variables for L1

H2 Predictor Variables for Constellation Station	Estimate	Odds Ratio	P-value
I take public transport because someone whose opinion I value believes that I should.	-0.105	0.900	0.738
My choice to take public transport is influenced by someone close to me doing the same (family member/friend/colleague).	0.066	1.069	0.831
I will not use public transport in a given situation if someone I know had a bad experience with the same service.	0.611	1.842	0.033
Model fit	Hosmer–Lemeshow test = 0.63 > 0.05		

**TABLE 6.**  
A2 Predictor Variables for L2

H2 Predictor Variables for Constellation Station	Estimate	Odds Ratio	P-value
I take public transport because someone whose opinion I value believes that I should.	0.412	1.510	0.239
My choice to take public transport is influenced by someone close to me doing the same (family member/friend/colleague).	-0.148	0.862	0.600
I will not use public transport in a given situation if someone I know had a bad experience with the same service.	-0.008	0.992	0.976

Results of the analysis indicated that the model for L1 adequately fits the dataset. During data collection, a number of participants verbally commented that the choice to take PT was their own when completing items related to obligation and willingness to comply with societal expectations. The use of PT is therefore shown to be a choice that is not influenced by an individual's perceptions of social obligations or the desire to gain the approval and acceptance of important referents ( $p > 0.05$ ). However, the results indicate that social norms can serve as an information source used when forming attitudes towards PT. The experiences of other users influence an individual's



willingness to ride a particular service ( $p$ -value = 0.033). The insignificance of this measurement item within L2 may be attributed to the lack of alternative travel modes. When making commuter trips for the purpose of work and education, users within the L2 surroundings are presented with travel options of driving with limited route choices or using the PT services available at L2. Due to this lack of choice, users are more likely to continue using existing PT services at L2 despite negative experiences. For instance, knowledge of a negative PT experience may still be more desirable than driving within peak-hour congestion. Overall, the findings within both L1 and L2 demonstrate that the action of using PT in Auckland is more likely to be influenced by self-interest rather than pro-social motives.

Future research will further investigate the factors within the information received from others that are most influential to attitude. Factors may include weather, safety and security, time-related attributes, crowding, and information.

## **Conclusion**

Globally, countries are struggling with travelers' high dependency on private vehicles. Due to the comfort and flexibility offered by private vehicles, the loyalty of existing PT users to continue ridership is uncertain. The present study investigated existing users' attitudes towards PT from two perspectives. First, the effects of accessibility to destinations with PT and the ease of access to terminals on existing users' attitudes is determined; second, the contribution of social norms, as an information source, in the formation of users' attitudes towards the use of PT. Selected elements of the built environment surrounding terminals and network connectivity were used to measure access and accessibility, respectively. Two assumptions were tested. A user-preference survey was undertaken in Auckland, New Zealand, at two terminals with different provisions for service coverage and access. Data were analyzed using ordinal and logistic regression models.

Findings suggested that ease of access to terminals and accessibility to various destinations have an effect on existing users' satisfaction with ridership. This result raises the profile that although commuters have already decided to use PT, access to terminals and accessibility to various destinations remain as influential factors. "Reaching work/education" and "reaching other suburbs" were statistically significant, and trips which included errands and recreational activities were insignificant. The result is sensible, as errands and recreational trips create physical obstacles due to additional commodities (e.g., grocery shopping bags, bikes, strollers). Within the L1 dataset, more PT users accessed the terminal by walking; in the L2 dataset, more users accessed by driving. This can be attributed to the built environment and residential density surrounding each location. The greater residential density surrounding L1 in conjunction with the better quality built environment, in terms of safety, enables higher volumes of pedestrians to access the terminal. Despite L1 being located adjacent to a major highway and being surrounded by cul-de-sacs that decrease permeability, the results of the study indicate that these two attributes of urban planning can successfully encourage affected residents to favor pro-environmental transport modes. In regards to the effects of social norms on attitude, the results found that social norms are used as a source of

information by existing users. Negative experiences of others were seen to have an effect on existing users' intention to continue ridership in L1, where commuters are given higher-quality transport choices than L2 in terms of journey time and convenience. In summary, it is recommended that planners place importance on increasing the ease of access to terminals and accessibility to various destinations such that existing patronage can be sustained in the long term.

## References

- Ajzen, I. 1991. "The Theory of Planned Behavior." *Organizational Behavior and Human Decision Processes*, 50(2): 179-211.
- Ajzen, I. 2005. *Attitudes, Personality and Behavior* 2. New York: McGraw-Hill.
- Auckland Council. 1999. Auckland Council District Plan Operative Papakura Section 1999. Retrieved March 9, 2015, from <http://www.aucklandcouncil.govt.nz/EN/planspoliciesprojects/plansstrategies/DistrictRegionalPlans/papakuradistrictplan/Pages/districtplanmapshome.aspx>.
- Auckland Transport. 2015. Park & Ride. Retrieved December 15, 2015, from <https://at.govt.nz/driving-parking/parking-in-auckland/park-ride/>.
- Bamberg, S., M. Hunecke, and A. Blobaum. 2007. "Social Context, Personal Norms and the Use of Public Transportation: Two Field Studies." *Journal of Environmental Psychology*, 27(3): 190-203.
- Banaji, M. R., and L. Heiphetz. 2010. *Handbook of Social Psychology*. New Jersey: John Wiley & Sons, Inc.
- Beirao, G., and J. A. Sarsfield-Cabral. 2007. "Understanding Attitudes Towards Public Transport and Private Car: A Qualitative Study." *Transport Policy*, 14(6): 478-489.
- Bently, I., A. Alcock, P. Murrain, S. McGlynn, and G. Smith. 1985. *Responsive Environment: A Manual for Designers*. London: Architectural Press.
- Bertolini, L., F. Le Clercq, and L. Kapoen. 2005. "Sustainable Accessibility: A Conceptual Framework to Integrate Transport and Land Use Plan-Making. Two Test-Applications in the Netherlands and a Reflection on the Way Forward." *Transport Policy*, 12: 207-220.
- Black, W. R., and N. Sato. 2007. "From Global Warming to Sustainable Transport 1989-2006." *International Journal of Sustainable Transportation*, 1(2): 73-89.
- Borjesson, M. 2012. "Valuing Perceived Insecurity Associated with Use of and Access to Public Transport." *Transport Policy*, 22: 1-10.
- Brog, W., E. Erl, I. Ker, J. Ryle, and R. Wall. 2009. "Evaluation of Voluntary Travel Behavior Change: Experiences from Three Continents." *Transport Policy*, 16(6): 281-292.
- Carrus, G., P. Passafaro, and M. Bonnes. 2008. "Emotions, Habits and Rational Choices in Ecological Behaviors: The Case of Recycling and Use of Public Transportation." *Journal of Environmental Psychology*, 28(1): 51-62.

- Ceder, A., Y. Le Net, and C. Coriat. 2009. "Measuring Public Transport Connectivity Performance Applied in Auckland." *Transport Research Record*, 2111: 139-147.
- Chapman, L. 2007. "Transport and Climate Change: A Review." *Journal of Transport Geography*, 15(5): 354-367.
- Chowdhury, S., A. Ceder, and B. Schwalger. 2015. "The Effects of Travel Time and Cost Savings on Commuters' Perception of Public Transport Routes Involving Transfers Using Just Noticeable Difference." *Journal of Transport Geography*, 43: 151-159.
- Crano, W. D., and M. B. Brewer. 2002. *Principles and Methods of Social Research*, 2<sup>nd</sup> Edition. Mahwah, New Jersey: Lawrence Erlbaum Associates, Inc.
- Eriksson, L., and S. E. Forward. 2011. "Is the Intention to Travel in a Pro-Environmental Manner and the Intention to Use the car Determined by Different Factors?" *Transportation Research Part D*, 16: 372-376.
- Gatersleben, B., and D. Uzzell. 2007. "Affective Appraisals of the Daily Commute." *Environment and Behavior*, 39(3): 416-431.
- Handy, S. 2008. "Regional Transportation Planning in the US: An Examination of Changes in Technical Aspects of the Planning Process in Response to Changing Goals." *Transport Policy*, 15(2): 17-24.
- Heath, Y., and R. Gifford. 2002. "Extending the Theory of Planned Behavior: Predicting the Use of Public Transportation." *Journal of Applied Social Psychology*, 32(10): 2154-2189.
- Hensher, D. A., and A. J. Reyes. 2000. "Trip Chaining as a Barrier to the Propensity to Use Public Transport." *Transportation*, 27(4): 341-361.
- Hiscock, R., S. Macintyre, A. Kearns, and A. Ellaway. 2002. "Means of Transport and Ontological Security: Do Cars Provide Psycho-Social Benefits to Their Users?" *Transportation Research Part D*, 7(2): 119-135.
- Kallgren, C. A., R. R. Reno, and R. B. Cialdini. 2000. "A Focus Theory of Normative Conduct: When Norms Do and Do Not Affect Behavior." *Personality and Social Psychology Bulletin*, 26(8): 1002-1012.
- Karash, K. H., M. A. Coogan, T. Adler, C. Cluett, S. A. Shaheen, I. Aizen, and M. Simon. 2008. "Understanding How Individuals Make Travel and Location Decisions: Implications for Public Transport." *TCRP Report 123*, Washington DC, Transportation Research Board: 1-147.
- Kleinbaum, D. G., and M. Klein. 2010. *Logistic Regression: A Self-Learning Text*. New York: Springer.
- Klockner, C., and E. Matthies. 2004. "How Habits Interfere with Norm-Directed Behavior: A Normative Decision-Making Model for Travel Mode Choice." *Journal of Environmental Psychology*, 24(3): 319-327.
- Manaugh, K., and A. M. El-Geneidy. 2012. "What Makes Travel 'Local': Defining and Understanding Local Travel Behavior." *Journal of Transport and Land Use*, 5(3): 15-27.

- Manaugh, K., and T. Kreider. 2013. "What is Mixed Use? Presenting an Interaction Method for Measuring Land Use Mix." *Journal of Transport and Land Use*, 6(1): 63-72.
- Mavoa, S., K. Witten, T. McCreanor, and D. O'Sullivan. 2012. "GIS-based Destination Accessibility via Public Transit and Walking in Auckland, New Zealand." *Journal of Transport Geography*, 20: 15-22.
- May, T. 2011. *Social Research: Issues, Methods and Process*. Maidenhead, England: McGraw-Hill Education.
- Ministry of Transport. 2014. "Comparing Travel Modes: New Zealand Household Travel Survey 2010–2013." Wellington, New Zealand: 1-19.
- Murray, A. T. 2001. "Strategic Analysis of Public Transport Coverage." *Socio-Economic Planning Sciences*, 35: 175-188.
- Murray, A. T. 2003. "A Coverage Model for Improving Public Transit System Accessibility and Expanding Access." *Annals of Operations Research*, 123: 143-156.
- Murray, S. J., D. Walton, and J. A. Thomas. 2010. "Attitudes Towards Public Transport in New Zealand." *Transportation*, 37(6): 915-929.
- Saelens, B. E., and S. L. Handy. 2008. "Built Environment Correlates of Walking: A Review." *Medicine and Science in Sports and Exercise*, 40: 1-14.
- Singleton, R. A., Jr., and B. C. Straits. 2005. *Approaches to Social Research, 4<sup>th</sup> Edition*. New York: Oxford University Press, Inc.
- Speck, J. 2012. *Walkable City: How Downtown Can Save America One Step at a Time*. New York: Farrar, Straus and Giroux.
- Stanton, N. A., R. C. McIlroy, C. Harvey, S. Blainey, A. Hickford, J. M. Preston, and B. Ryan. 2013. "Following the Cognitive Work Analysis Train of Thought: Exploring the Constraints of Modal Shift to Rail Transport." *Ergonomics*, 56(3): 522-540.
- Stewart, O. T., and A. V. Moudon. 2014. "Using the Built Environment to Oversample Walk, Transit and Bicycle Travel." *Transportation Research Part D*, 32: 15-23.
- Uherek, E., T. Halenka, J. Borken-Kleefeld, Y. Balkanski, T. Berntsen, C. Borrego, M. Gauss, P. Hoor, K. Juda-Rezler, J. Lelieveld, D. Melas, K. Rypdal, and S. Schmid. 2010. "Transport Impacts on Atmosphere and Climate: Land Transport." *Atmospheric Environment*, 44: 4772-4816.
- Zhang, L., J. Hong, A. Nasri, and Q. Shen. 2012. "How Built Environment Affects Travel Behavior: A Comparative Analysis of the Connections between Land Use and Vehicle Miles Traveled in US Cities." *Journal of Transport and Land Use*, 5(3): 40-52.

## About the Authors

**SUBEH CHOWDHURY** ([s.chowdhury@auckland.ac.nz](mailto:s.chowdhury@auckland.ac.nz)) is a Lecturer at the University of Auckland in the Department of Civil and Environmental Engineering. She worked with two international engineering consultancies in New Zealand prior to joining the university in 2014 and has publications in reputable journals such as *Transport Policy*, *Journal of Public Transportation*, and *Journal of Transport Geography*.

**KASEY ZHAI** ([kzha041@aucklanduni.ac.nz](mailto:kzha041@aucklanduni.ac.nz)) is a final-year student at the School of Architecture and Planning at the University of Auckland. She received a summer scholarship from the Faculty of Engineering to conduct this research study.

**ASIF KHAN** ([asif.khan@auckland.ac.nz](mailto:asif.khan@auckland.ac.nz)) is a Senior Lecturer at the School of Architecture and Planning at the University of Auckland. He has more than 15 years of experience as an academic, including 10 years at the University of Sydney and the University of Auckland. He holds Ph.D. and Master of Urban and Regional Planning (Honours) degrees from the University of Sydney and a Bachelor of Civil Engineering degree from Bangladesh University of Engineering and Technology, Dhaka. His current research interests are in the areas of travel behavior, travel plans, and housing policies.

---

# Optimization of Main Public Transport Paths Based on Accessibility— Case Study: Mashhad, Iran

Houman Shadab Mehr, Mohamad Rahim Rahnama, Mohamad Ajza Shokouhi,  
and Ezatollah Mafi  
Ferdowsi University of Mashhad

---

## Abstract

*Transport planning is an important aspect of urban planning. In this regard, enhancement of public transport systems and guiding urban travels towards them has found a crucial role in traffic improvement, preventing capital waste, and achieving sustainable cities. Mashhad, Iran, the second largest city in Iran, with a population of three million, has two main systems of public transport, light rail transit (LRT) and bus rapid transit (BRT). In designing these lines, not enough attention was paid to urban sustainability principles and maximizing access. The aim of this study was to redesign the main public transport lines using the approach of accessibility enhancement. The meta-heuristic method of Ant Colony Optimization was applied for this purpose. To compare the redesigned paths with the current paths, access indicators were defined and computed in the case of two alternatives. The results show that the access indicator in the modified alternative is significantly higher than the current one.*

## Introduction

Traffic density is one of the main problems of big cities in developing countries (Pardo 2010). Regarding the high cost of transport and its profound impact on the economy of a country, this issue is one the most important subjects studied in different societies (Behbahani and Asadikiya 2010). Therefore, transport planning is an important aspect of urban planning. In this regard, enhancement of public transport systems and guiding urban travels towards them has found a crucial role in decreasing traffic problems. In fact, public transport as a basic component of urban transport has played an undeniable role in improving living conditions in cities, such that imagining a medium or large city without it seems impossible. In large cities of the world, public transport constitutes 50% of urban travel. Nowadays, urban planners, to respond to people displacement requirements, have established urban development patterns on the basis of public transport and its expansion.



### Research Location

The study took place in Mashhad, Iran, the second largest city in Iran, with a resident population of 3 million and more than 20 million pilgrims yearly. The city has a relatively high vehicle density, and traffic has increased rapidly in recent years. Related to transit, the situation of Mashhad is representative of many cities in developing countries. Figure 1 illustrates location of Mashhad.

**FIGURE 1.**  
Location of Mashhad



The main public transport systems of Mashhad are bus rapid transit (BRT) and light rail transit (LRT), referred in this paper as the framework of public transport. In the planning for Mashhad, four BRT and four LRT lines were predicted (see Figure 2). To date, lines BRT1 and LRT1 have been constructed and line BRT2 and LRT2 are under construction. According to plans, all lines must be constructed and implemented in the next 10 years.

**FIGURE 2.**  
Current LRT and BRT lines of Mashhad



Source: Transport Research Center of Sharif Industrial University 2003, 2008

### **Research Problem**

In determining the current lines of the public transport framework of Mashhad, sustainable city principles and geographical properties of the city have not been sufficiently considered. As can be seen in Figure 2, the current paths of the LRT and BRT lines overlap in most places (50% of their length), which results in a reduction in the coverage area of the system. Overlapping of main public transport lines is not a problem by itself, as this condition exists in many large cities, but financing problems and limitations have led to the limitation of public transport in Mashhad. In these circumstances, concentration of public transport facilities into one or several paths will result in the impossibility of their development in the rest of the regions. Also, the objective of the current LRT and BRT lines of Mashhad was based on traffic index improvements, such as an increase in the average speed in the street network. The paths of these lines were determined by optimizing the traffic indices and maximizing the mobility characteristics of the city.

### **Research Objective**

The aim of this study was to modify the current framework of the Mashhad public transport system and resolve its problems based on sustainable city principles and consideration of accessibility over mobility concepts, with special attention to the geographical characteristics of urban areas such as the settlement and employment centers of city and geometrical properties of the street network.

### **Research Background**

The problem of optimizing the public transport paths of large networks is a complicated issue that cannot be solved by the ordinary optimization methods in mathematics (Hosapujari and Verma 2013). Various problems in solving public transport optimization include non-linearity, state of being non-convex, multi-target function, and the like (Ayati and Bagheri 2006). One innovative method for solving the optimization problem of public transport paths was presented by Mandl (1979), comprising two steps. In the first step, a primary possible network is created, and in the second step, a target function in the form of the total time of travelers, including on-means time and waiting time, is minimized. This algorithm does not consider the travel demand in the network construction stage. In Mandl's algorithm, the emphasis is on the network's coverage and direct paths (Mandl 1979).

Throughout following years, other methods were proposed for solving these problems, such as localizing a path from the rapid transit system with population coverage insight considering interstation distances and source-destination demand.

For Mashhad, two studies were conducted by the Transport Research Center of Sharif Industrial University. In the first study, to present good rail alternatives for Mashhad, comments from responsible authorities and experts of the Mashhad transport system were collected on the LRT paths with a high probability of construction. Alternatives were presented according to criteria such as movement tendency lines, potential capacity of different paths, authority comments, and expert analysis and the possibility of the development and expansion of the lines. The study resulted in the determination

of four paths for the LRT system of Mashhad (Transport Research Center of Sharif Industrial University 2003).

The second study focused on the design of BRT lines in Mashhad. The street network of the city was updated and, by estimations of population, car ownership, average number of people on board, and statistics on volume and passenger counting in shear lines, the information on travel demand also was updated. Different choices of bus networks were created, and a multi-target assessment was applied. The final alternative was determined after controlling the results of traffic allocation to the network using EMME/2 software and evaluation of traffic indices (Transport Research Center of Sharif Industrial University 2008).

### **Theoretical Basis**

The theory behind the present study is for a sustainable city with emphasis on increased accessibility (justified distribution of public transport service). It is worth noting that for development of public transport systems, consideration of the accessibility parameter is crucial.

One of the most important subjects in urban studies is justified access to facilities (Rahnam and Aghajani 2013). The aim of accessibility planning is reaching sustainable development by transitioning from mobility or speed increase to accessibility or reducing the distance between home and office, resulting in decreased fuel consumption and environmental pollution. Therefore, accessibility planning is a tool for achieving sustainable development (Rahnam and Forghani 2008).

The accessibility concept has been considered from different aspects such as physical, mental, economic, and financial, which could be related to the functional nature of the land and transport network (Kaphle 2006). Accessibility has been addressed as one of the functional axes for the spatial shape of cities. Contemporary theorists have noted accessibility as one of the main advantages of urban areas, and most theories on the appearance and function of cities note it as an evident fact. Moreover, development based on transport properties along with rail public transport has been recognized as a method for sustainable development of metropolitan areas. In comparison with cities that are dependent on personal transport, development, along with precise and correct design and implementation of public transport systems, could continuously reduce traffic and prevent urban scattering due to increased population, such that transport-based development is considered a method for sustainable development (Xiaosu and Hong 2013).

### **Research Methodology**

To redesign the LRT and BRT lines, Ant Colony Optimization (ACO) was applied. The mean distance from the zone center to the nearest LRT or BRT line was measured in case of current and modified alternatives ( $D_c$  and  $D_m$ ). To calculate the mentioned distances, GIS software was used, and the Hansen method was applied to compute the access indicator ( $I_a$ ). Finally, to compare the  $I_a$  in case of the current and modified alternatives, an independent sample t-test using SPSS software was used.

### **Ant Colony Algorithm**

Transit systems sometimes are designed using very detailed cost models (Uchimuri, Takashi, and Saitoh 2002). Designing a public transport network is a sophisticated issue, so, in general, metaheuristic methods are used (Sivakumaran, Cassidy, and Madanat 2014). These methods, including genetic algorithm, ACO, and simulated cooling and warming algorithms, have been used widely for public transport network design and have led to appropriate answers for large-scale problems. In this research, redesign of the LRT and BRT lines of Mashhad was conducted using ACO.

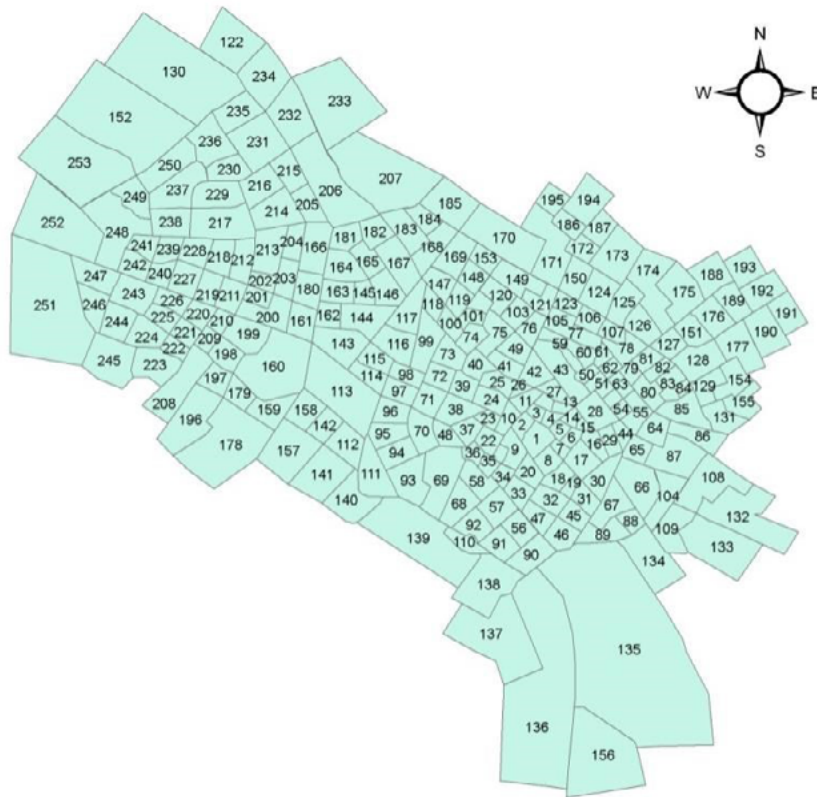
Differentiating this study from those conducted previously is the target function of the algorithm.

Ant colonies or social insect societies have a highly-structured social organization. One of the results of this organization is carrying out complicated tasks and resolving problems of daily life, which are more than the ability of an individual ant (Dorigo, Maniezzo, and Colorni 1996). These types of behaviors observed in specific groups of insects are called “swarm intelligence” (Ghoseiri and Morshedsolouk 2006). ACO was developed by an experiment performed by Goss et al. in 1989, who were inspired by the behavior of ants in optimizing the path from the ant nest to food resources. In moving from the nest to a food resource, the ants release pheromones, which disappear after a while. Therefore, as time passes, the more-used paths will have higher amounts of pheromones and the low traffic paths would be eliminated (Goss et al. 1998). (For further information on ACO, refer to Dorigo and Stutzle 2004). The algorithm of public transport path determination includes a desirable function and several limitations. Path lines are defined on the street network, which includes a series of nodes (junctions) and arcs (streets). The algorithm is written in a way such that each path line is determined in a node-to-node format according to the desired function that would satisfy the defined limitations.

### **Research Variables**

The research variables were selected to make it possible to modify the LRT and BRT paths based on enhancing the relationship of settlement centers with travel centers. To determine the research variables, Mashhad was divided into 253 zones, as shown in Figure 3.

**FIGURE 3.**  
Mashhad city zoning in  
GIS environment



Research variables were defined as follows:

- $P_i$ : population of zones
- $W_j$ : number of employed people in job location
- $VK_j$ : number of business units in zones (representing commercial application)
- $K_j$ : number of the clerks in the job location (representing of administrative application)
- $APARK_j$ : park areas in zones (representing recreational application)

It must be noted that education is an important travel-absorbing application, but due to attempts of urban planners to guide these travels towards walking or cycling travels (via closing up the distances between homes and schools), it has not been regarded as a determining factor in defining the public transport line framework.

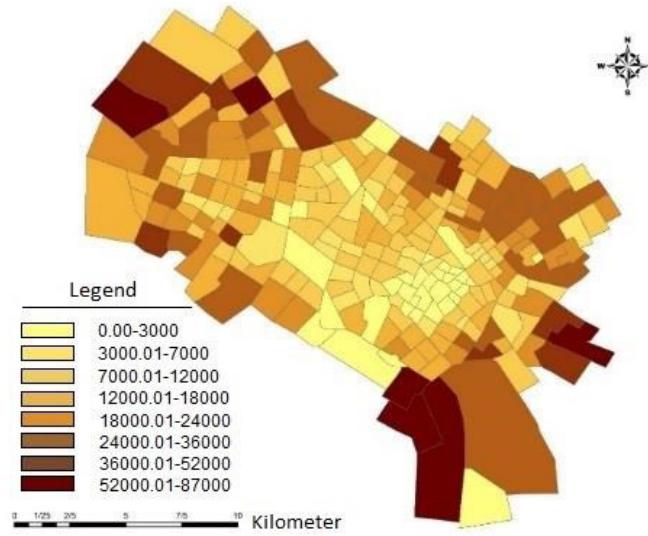
All variables were estimated for each of the 253 zones in timetable of the project (2026).

#### **Values of Variables**

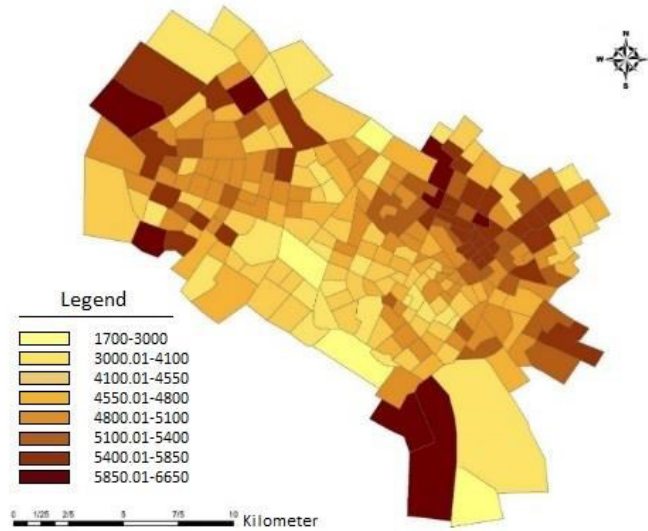
The values of the variables are presented graphically for the 253 zones in Figures 4 through 8, which show the variable value range of  $P_i$ ,  $W_j$ ,  $VK_j$ ,  $K_j$ , and  $APARK_j$  in the zones consecutively. The variables of the research were derived from the Mashhad transport comprehensive studies database and entered into GIS software.



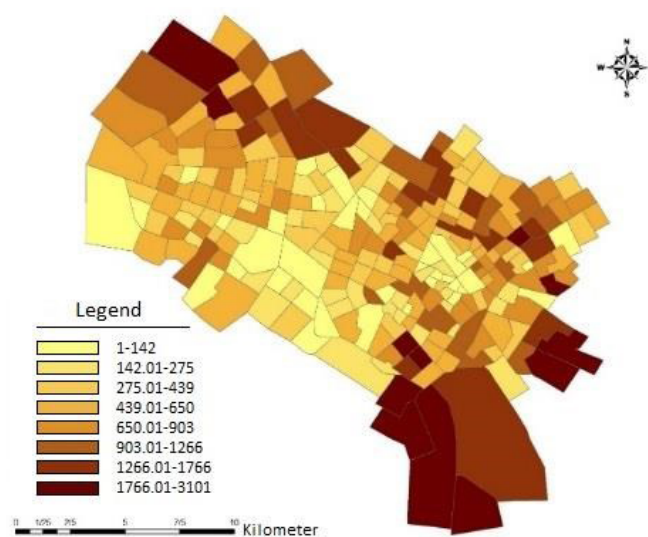
**FIGURE 4.**  
Variable value ranges of  
population ( $P_i$ )



**FIGURE 5.**  
Variable value ranges of  
employed people in job  
locations ( $W_j$ )

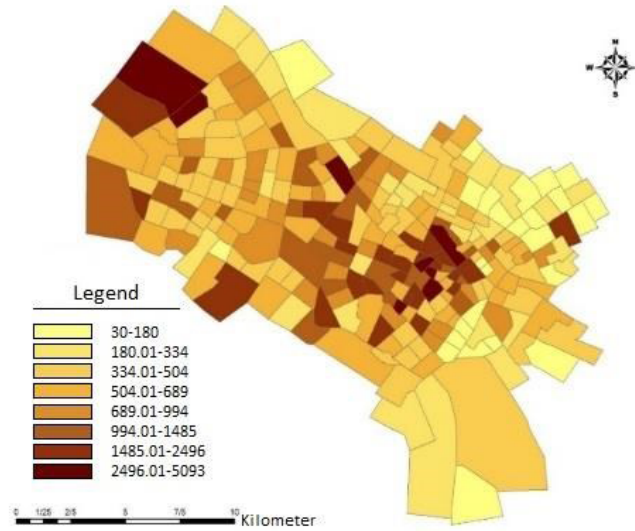


**FIGURE 6.**  
Variable value ranges of  
business units ( $VK_j$ )

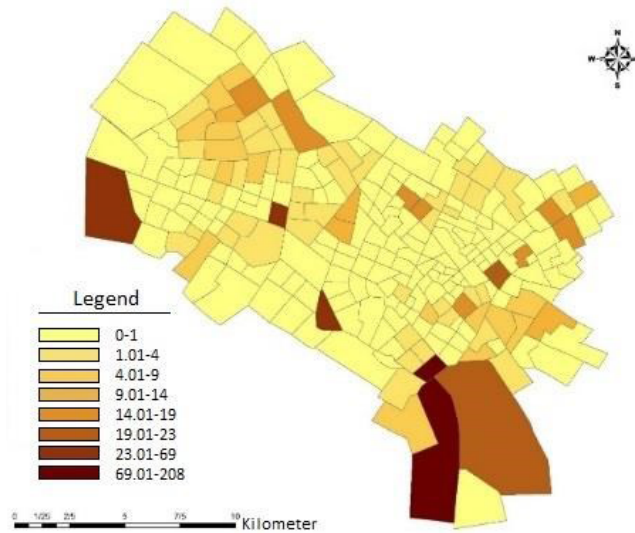




**FIGURE 7.**  
Variable value ranges of clerks in job location ( $K_j$ )



**FIGURE 8.**  
Variable value ranges of park areas (APARK<sub>j</sub>)



## Redesign of LRT and BRT Lines Using ACO

### *Desirability Function*

Choosing an arc by an ant depends on the desirability of that arc (its advantages). The desirability function of every arc of the network includes two parts: the amount of pheromones on the arc and the advantages of the end node of the arc, which includes population and the level of travel absorbing applications in the vicinity of that node. Equation 1 shows the desirability function:

$$U_{ij} = \tau_{ij} + p_j + k_j \quad (1)$$

where  $U_{ij}$  is the desirability related to selection of  $j$  node from select node of  $i$  (or  $[i,j]$  arc),  $\tau_{ij}$  is the amount of pheromone on the  $(i,j)$  arc,  $P_j$  is the population in the vicinity of the  $j^{\text{th}}$  node, and  $k_j$  is the level of travel-absorbing application in the vicinity of the  $j^{\text{th}}$  node.

The probability equation of choosing an arc by an ant via a logit model is defined as follows:

$$P_{ij} = \frac{e^{U_{ij}}}{\sum_{(i,j) \in (\text{feasible})_i} e^{U_{ij}}} \quad (2)$$

where  $P_{ij}$  is the probability of choosing  $j^{\text{th}}$  node from  $i^{\text{th}}$  node ( $(i,j)$  arc) and  $(\text{feasible})_i$  indicates the series of arcs for the  $i^{\text{th}}$  node that satisfy the condition, and  $U_{i,j}$  is calculated from Equation (1).

Pheromonization is done by means of the paths in the previous iterations. For selecting each arc, 100 iterations were done.

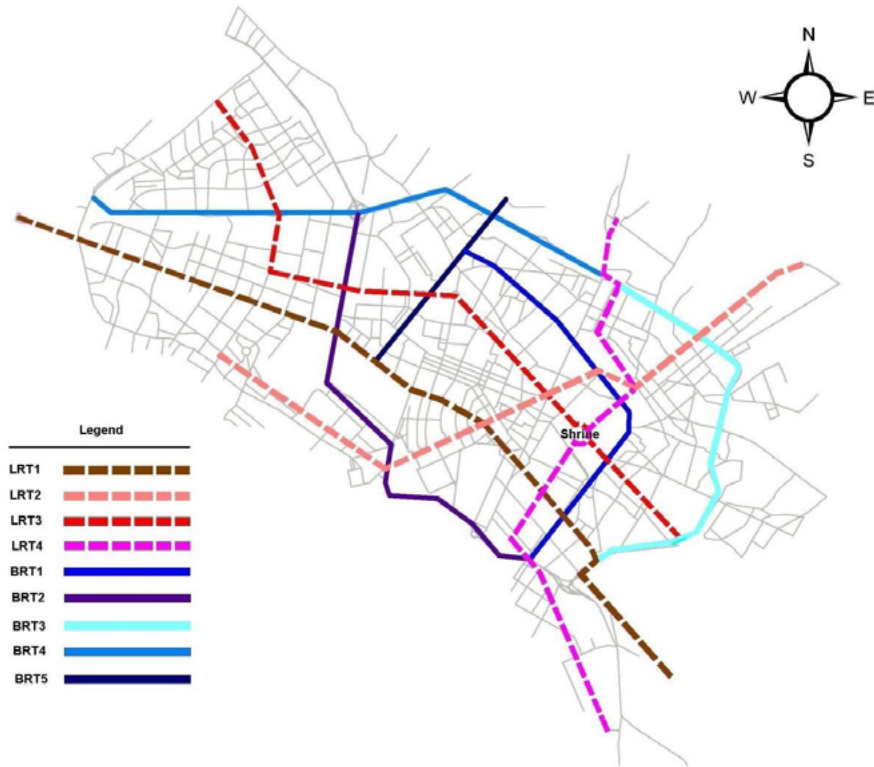
### Limitations

In addition to the limitations related to the physical properties of the passages that must have the capability for LRT and BRT traffic, the other important limitation is associated with budget. Normally, a budget limitation is applied via limiting the line length. In this study, as the objective was to compare the proposed line paths with the current ones, it was assumed that the length of the proposed lines differ with the current lines by only 5%. Also, as the paths of LRT lines 1 and 2 were implemented in the earth, they are assumed to be fixed and unchangeable.

### Algorithm Implementation

The algorithm was run in the environment using MATLAB software to determine the path in a node-to-node (junction-to-junction) format. Thus, the possibility of manual modification of the path in any network node (due to specific conditions undefined in the algorithm) was predicted, i.e., if in the process of path provision, modification of a specific node is required, the modifications will be applied in the system and the next node will be determined by the software. This process is repeated throughout the path. Figure 9 shows the LRT and BRT paths that resulted from the research algorithm. The characteristics (length and level of overlap) of the BRT and LRT paths of Mashhad in the current condition and the modified levels are presented in Table 1.

**FIGURE 9.**  
Modified paths of public transport framework on Mashhad street network



**TABLE 1.**  
Comparison of Current LRT and BRT lines with Modified Alternative

Main Public Transport Lines	Characteristics		
	Line Length (m)	Overlap Path Length (m)	Difference of Modified Alternative Relative to Current Choice (%)
Current lines			
LRT	75,668	32,086	-
BRT	63,162	32,086	-
BRT and LRT	138,830	64,172	-
Modified lines			
LRT	79,841	0	+5.51
BRT	57,533	0	-8.91
LRT and BRT	137,374	0	-1.05

### Computation of Access Indicator

The ultimate goal of most transportation is “access,” the ability to reach desired goods, services, and activities. Transportation decisions often involve tradeoffs between different forms of access (Litman 2011). Accessibility expresses the relationship between the land use system and the transportation system serving it (Nuzzolo, Coppola, and Papa 2014).

A review of accessibility measures by Handy and Niemeier (1997) suggests three general categories of measures: gravity-based measures, cumulative opportunity measures,

and behavioral measures. Gravity-based measures are derived from the gravity model of spatial interaction. In deriving gravity-based measures of accessibility, destination opportunities such as employment are weighted by the cost of their interaction, which usually is specified by the distance decay function component of the gravity model, often taking on the familiar negative exponential form. Thus, a measure of Hansen (1959) accessibility, which is based on the gravity model, could be specified as:

$$A_{ik} = \sum W_{kj} f_{ij} \quad (3)$$

where  $i$  and  $j$  are subareas,  $W_k$  is a total population of opportunities, and  $W_{kj}$  is a sub-population of opportunities (Harris 2001). The function  $f_{ij}$  represents the cost of travel as impedance to interaction.

Equation (4) was developed based on the above general equation:

$$A_t = A_{pi} + A_{ej} \quad (4)$$

where  $A_t$  is the total access index,  $A_i$  is the access index related to population on origin  $i$  (equation N.5), and  $A_{ej}$  is the access index related to employment at destination  $j$  (Equation [6]).

$$A_{pi} = \sum_{i=1}^n P_i d_i^{-2} \quad (5)$$

where  $n$  is number of zones (253),  $P_i$  is population on origin  $i$ , and  $d_i$  is distance from the center of the zone  $i$  to the nearest LRT or BRT line.

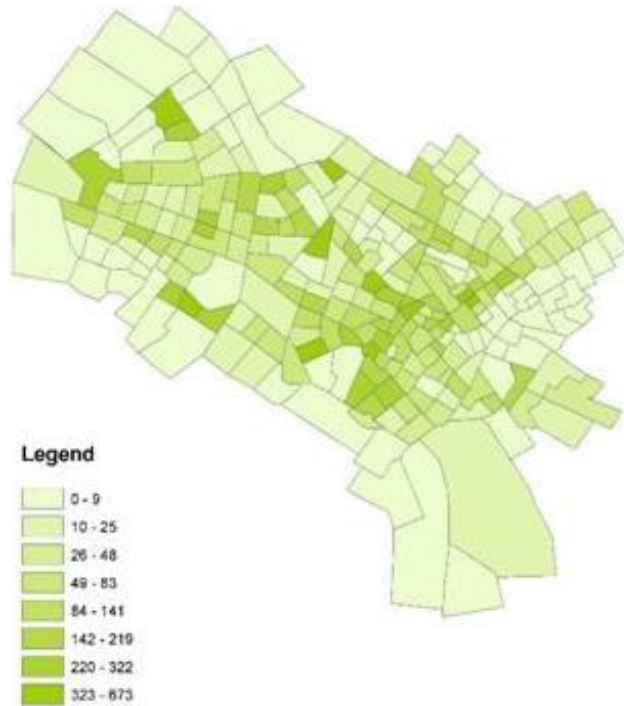
$$A_{ej} = \sum_{j=1}^n E_j d_j^{-2} \quad (6)$$

where  $E_j$  is employment at destination (zone  $j$ ).

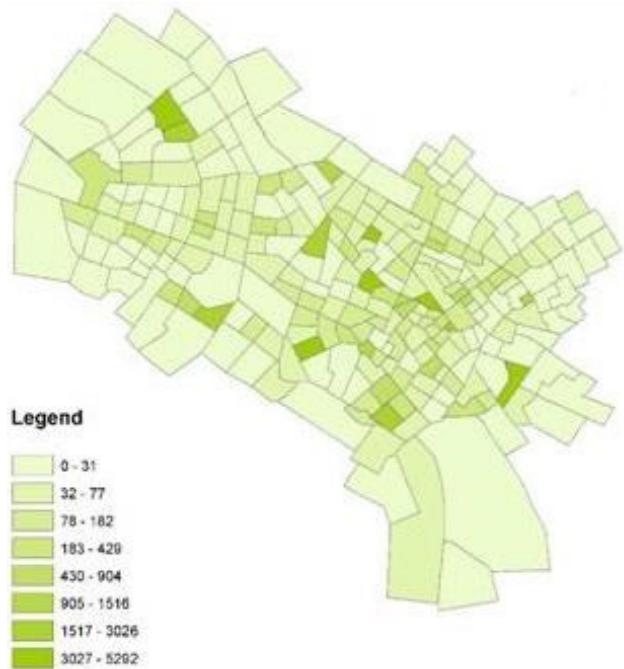
The mean distance from zone center to the nearest LRT or BRT line were measured, and then the access level to the LRT and BRT network in the cases of the current ( $A_c$ ) and modified ( $A_m$ ) alternatives were calculated separately for each zone using equations 4, 5, and 6.

The value ranges of  $A_c$  and  $A_m$  are presented graphically for the 253 zones of the city in Figures 10 and 11, which show the  $A_c$  and  $A_m$  ranges in the zones consecutively.

**FIGURE 10.**  
Value ranges of  $A_c$  in zones



**FIGURE 11.**  
Value ranges of  $A_m$  in zones



The hypothesis is that  $A_m$  is significantly higher than  $A_c$ . For testing the hypothesis, an independent samples T-test was performed using SPSS software, and the results are shown in Tables 2 and 3. According to the obtained results ( $\text{sig.} < 0.05$ ), the hypothesis is confirmed.

**TABLE 2.**  
Group Statistics

	Groups	N	Mean	Std. Deviation	Std. Error Mean
Mean access level	1 (Current)	253	0.0775	0.11260	0.00708
	2 (Modified)	253	0.2393	0.71228	0.04478

**TABLE 3.**  
Independent Samples Test

		Levene's Test for Equality of Variances		T-Test for Equality of Means		
		F	Sig.	t	df	Sig. (2tailed)
Mean access level	Equal variances assumed	40.496	0.000	-3.569	504	0.000
	Equal variances not assumed			-3.569	264.588	0.000

### Conclusion and Recommendations

The origin of speed- and movement-based thoughts in urban transportation planning goes back to the 1950s–70s, the period of personal cars dominance in cities of industrialized countries. Today, to overcome the traffic issues of large cities and their associated heavy costs (air pollution, loss of citizen time, consumption of limited energy sources), urban sustainability has gained considerable attention and, accessibility is of particular importance for urban planners. In this context, public transport needs more consideration due to its key role in urban movement, and increasing its level of accessibility can be basic factor in encouraging people to use transit instead of cars. Accessibility is the main feature of public transportation in sustainable cities. Therefore, due to the importance of public transport, increasing its coverage level and maximizing its accessibility are regarded as the most important factors in designing the systems. In addition, in designing a framework of public transportation in cities, different criteria should be considered and their optimization requires application of sophisticated methods.

The ant colony algorithm is a well-known method for designing networks and is capable of fulfilling acceptable levels of desirable criteria by correctly defining target functions and limitations. In this research, to maximize the accessibility of a system, population and level of trip-absorbing applications were used as target functions, and the remaining effective factors were defined as limitations. The results show that the produced framework of public transportation, in comparison with the existing network, has a significant difference in terms of increasing accessibility and has higher coverage. Also, as physical limitations of the passages were considered in solving the algorithm, the proposed network will face fewer problems in the implementation step.

The results of the present study show the conflict of two thoughts—development based on mobility and development according to accessibility principles. Therefore, by adapting each way of thinking, designers of public transport systems can obtain different results, the neglect of which could lead to considerable negative consequences.

The following suggestions are presented for definition and future studies:



- As traffic consultants usually consider the same principles for public transport design, this study shows the difference between public transport design according to sustainable development principles (accessibility) and movement-based methods; it is suggested to conduct similar studies in the other countries and apply the required modifications in future developments.
- The ant colony algorithm is based on a target function definition, as various parameters such as passed time, level of limited sources of energy consumption, extent of production and absorption of trips, level of environmental pollutant production, and level of cost/benefit can be placed in the target function. It is suggested to change the target function and compare the newly-produced networks in terms of coverage level and accessibility index.

## References

- Ayati, E., and M. Bagheri. 2006. "Coverage Method for the Location of a Light Rail Transit (LRT)." *Transportation Research Journal (Pajouheshnameh Haml va Naghl)*, 3: 1-11.
- Behbahani, H., and H. Asadikiya. 2010. "Assessment Strategies in Intelligent Transportation Systems (ITS) of Traffic Safety View Point." 10<sup>th</sup> international Conference on Traffic & Transportation Engineering, Tehran, Iran.
- Dorigo, M., and T. Stutzle. 2004. *Ant Colony Optimisation*. Boston: MIT Press.
- Dorigo, M., V. Maniezzo, and A. Colomi. 1996. "The Ant System: Optimization by a Colony of Cooperating Agents." *IEEE Transactions on Systems, Man, and Cybernetics—Part B*, 26(1): 1-13.
- Ghoseiri, K., and F. Morshedsolouk. 2006. "ACS-TS: Train Scheduling Using Ant Colony System." *Journal of Applied Mathematics and Decision Science*: 1-28.
- Goss, S., S. Aron, J. L. Deneubourg, and J. M. Pasteels. 1998. "Self-Organized Shortcuts in the Argentine Ant." *Naturwissenschaften*, 76: 579-581.
- Handy, S. L., and D. A. Niemeier. 1997. "Measuring Accessibility: An Exploration of Issues and Alternatives." *Environment & Planning A*, 29(7): 1175-1194.
- Hansen, W. 1959. "How Accessibility Shapes Land Use." *Journal of the American Institute of Planners*, 25(1): 73-76.
- Harris, B. 2001. "Accessibility: Concepts and Applications." *Journal of Transportation and Statistics*, 4(2/3): 15-30.
- Hosapujari, A. B., and A. Verma. 2013. "Development of a Hub and Spoke Model for Bus Transit Route Network Design." *Procedia – Social and Behavioral Sciences*: 835-844.
- Kaphle, I. 2006. "Evaluating People's Accessibility to Public Parks using Geographic Information Systems: A Case Study in Ames, Iowa." Iowa State University.
- Litman, T. 2011. "Measuring Transportation: Traffic, Mobility and Accessibility." Victoria Transport Policy Institute, [www.vtpi.org](http://www.vtpi.org).

- Mandl, C. E. 1979. "Evaluation and Optimization of Urban Public Transportation Networks." *European Journal of Operational Research*, 5: 396-404.
- Nuzzolo, A., P. Coppola, and E. Papa 2014. "Marginal Activity Access Cost (MAAC): A New Indicator for Sustainable Land Use/Transport (LUT) Planning." *Procedia – Social and Behavioral Science*, 111: 450-459.
- Pardo, C. F. 2010. "Challenges of Urban Transport in Developing Countries—A Summary." [www.sutp.org](http://www.sutp.org).
- Rahnam, M. R., and H. Aghajani. 2013. "Analysis of Accessibility Index in Mashhad city." *Journal of Geography and Regional Development*, 20: 43-58.
- Rahnam, M. R., and H. Forghani. 2008. "Planning on Bus Accessibility in Iran, Case Study Mashhad City." *Journal of Spatial Planning*, 12(2): 73-96.
- Sivakumaran, K., Y. Li, M. Cassidy, and S. Madanat. 2014. "Access and the Choice of Transit Technology." *Transportation Research Part A: Policy and Practice*, 59: 204-221.
- Transport Research Center of Sharif Industrial University. 2003. "Designing the LRT Lines in Mashhad." Traffic and Transport Organization of Mashhad Municipality.
- Transport Research Center of Sharif Industrial University. 2008. "Designing the BRT lines in Mashhad," Traffic and Transport Organization of Mashhad Municipality.
- Uchimura, K., H. Takashi, and T. Saitoh. 2002. "Demand Responsive Services in a Hierarchical Public Transportation System." *IEEE Transactions on Vehicular Technology*, 51: 760-766.
- Xiaosu, M. A., and K. L. Hong. 2013. "On Joint Railway and Housing Development Strategy." *Transportation Research Part B*, 57: 451-467.

## About the Authors

**HOUMAN SHADAB MEHR** ([Ho\\_sh852@stu-mail.um.ac.ir](mailto:Ho_sh852@stu-mail.um.ac.ir)) is a Ph.D. candidate in Geography and Urban Planning at Ferdowsi University of Mashhad, International Campus.

**MOHAMAD RAHIM RAHNAMA** ([rahnama@um.ac.ir](mailto:rahnama@um.ac.ir)) is with the Department of Geography and Urban Planning at Ferdowsi University of Mashhad.

**MOHAMAD AJZA SHOKOUHI** ([Shokouhim@um.ac.ir](mailto:Shokouhim@um.ac.ir)) is with the Department of Geography and Urban Planning at Ferdowsi University of Mashhad.

**EZATOLLAH MAFI** ([mafi@um.ac.ir](mailto:mafi@um.ac.ir)) is with the Department of Geography and Urban Planning at Ferdowsi University of Mashhad.

## SUBSCRIPTIONS and PREVIOUS ISSUES

---

To subscribe or update your subscription to the *Journal of Public Transportation*, please visit [www.nctr.usf.edu/journal/subscriptions](http://www.nctr.usf.edu/journal/subscriptions).

Full-text issues of previous *Journal of Public Transportation* articles are available on the National Center for Transit Research website at [www.nctr.usf.edu/journal/full-text-issues](http://www.nctr.usf.edu/journal/full-text-issues).

## SUBMISSION OF MANUSCRIPTS

---

The *Journal of Public Transportation* is a quarterly, international journal containing original research and case studies associated with various forms of public transportation and related transportation and policy issues. Topics are approached from a variety of academic disciplines, including economics, engineering, planning, and others, and include policy, methodological, technological, and financial aspects. Emphasis is placed on the identification of innovative solutions to transportation problems.

All articles should be approximately 4,000 words in length (18–20 double-spaced pages). Manuscripts not submitted according to the journal's style will be returned. Submission of the manuscript implies commitment to publish in the journal. Papers previously published or under review by other journals are unacceptable. All articles are subject to peer review. Factors considered in review include validity and significance of information, substantive contribution to the field of public transportation, and clarity and quality of presentation. Copyright is retained by the publisher, and, upon acceptance, contributions will be subject to editorial amendment. Authors will be provided with proofs for approval prior to publication.

### Formatting Requirements

All manuscripts must be submitted electronically in MS Word format, with *no linked images*. Tables in the manuscript must be created in Word or Excel format and must not be inserted as images. Figures should be inserted as images and, to meet Section 508 compliance requirements, must have alternative text (a thorough description of the image to assist persons with visual impairments in understanding the image). All tables and figures must be numbered consecutively and have a title. All non-original figures and graphics must indicate the source; the author should retain written permission for use of any non-original images.

All manuscripts should include sections in the following order, as specified:

- *Cover Page* – title (12 words or less), author(s) affiliation(s) and email address(es), and address/telephone for corresponding author
- *Main Body* – title, paper abstract (up to 150 words), text organized under section headings (do not use section or subsection numbering)
- *References* – author-date format (*Chicago Manual of Style*)
- *Biographical Sketch* – brief information for each author; include email address

Be sure to include the author's complete contact information, including email address, mailing address, telephone, and fax number.

### Submit manuscripts via email to:

Lisa Ravenscroft, Assistant to the Editor

*Journal of Public Transportation*

National Center for Transit Research @ CUTR

Email: [jpt@cutr.usf.edu](mailto:jpt@cutr.usf.edu)

Phone: (813) 974-3120



## **Center for Urban Transportation Research**

College of Engineering  
University of South Florida  
4202 E. Fowler Avenue, CUT100  
Tampa, FL 33620-5375  
(813) 974-3120, fax (813) 974-5168